



جامعة حلوان
كلية الفنون الجميلة
قسم الديكور
شعبة العمارة الداخلية

العمارة الداخلية لمستشفيات الأطفال

The Interior Architecture of Children's Hospital

رسالة مقدمة من



للحصول على درجة الماجستير في الفنون الجميلة

قسم الديكور - شعبة العمارة الداخلية

إشراف

أ.د/ محي الدين محمد وهبة

أستاذ العمارة الداخلية غير متفرغ

قسم الديكور - كلية الفنون الجميلة - جامعة حلوان

إشراف مشارك

أ.د/ حسن عبد المنعم متولى

أستاذ العمارة الداخلية - قسم الديكور

كلية الفنون الجميلة - جامعة حلوان

2011

بِسْمِ اللَّهِ الرَّحْمَنِ الرَّحِيمِ

عَقْدُ الْبَيْتِ

:

.

)

(

إهداء

إلى من سالت دمائهم الذكية على أرض مصر
تعطر أرجائها... وترفرف أرواحهم فى سمائها
فصارت نجوما تلالاً... أضاءت عيون الوطن

لتبصر فجرا جديدا

إلى شهداء ومصابين ثورة 25 يناير

إلى الأبطال.. الأخفاء.. الأتقياء

إلى أسرتى الغالية

(والداى وأخوتى وجدتى

وإلى كل من ساندى جزاكم الله خيرا

•

• • •

•

فهرس محتويات البحث

الموضوع	الصفحة
المقدمة	
مشكلة البحث ، الأهمية ، الهدف ، حدود البحث	
فروض البحث، منهج البحث	

الباب الأول : نشأة المستشفيات وتصميمها

	:
.....	
.....	- -
.....().....	- -
.....	- -
.....	- -
.....	- - -
.....	- - -
.....	- - -
.....	- - -
.....	- - -
.....	- - -
.....	- -
.....	- - -
.....	- - -
.....	- - -
.....	- -
.....	- -
.....	- -
.....	- - -

.(- -) :

٢٠	- -
	- -
	- - -\)
	- -
	- - -
	- - -
	- - -
	- - -
	- -
	- -
	- - -
	- - -
	- - -
	- - -
	- -
	- - -
	- - -
	- - -
	- - -
	- - -
	- -
	- -
	- -
 (-)	- - -
 (-)	- - -
 (-)	- - -
 (-)	- - -\)
	- -\)

.....	- -)
.....	- - -
.....	- - -
.....	- -
.....	- - -
.....	- - -
.....	- - -
.....	- - -
.....	- -
.....	- - -

:

.....	
.....	- -
.....	- - -
.....	- - -
.....	- - -
.....	- - -
.....	- - -
.....	- - -
.....	- - -
.....	- - -
.....	- - -
.....	- - -
.....	- - -
.....	- -
.....	- - -
.....	- - -
.....	- - -
.....	- - -
.....	- - -
.....	- - -
.....	- - -
.....	- - -
.....	- - -

.....	- - - -
.....	- - - -
.....	- - - -
.....	- - - -
.....	- - - -
.....	- - - -
.....	- - - -
.....	- - - -

الباب الثانى : مكونات العمارة الداخلية لمستشفى الأطفال

_____ :

.....	
.....	- -
.....	- -
.....	- -
.....	- - - -
.....	- - - -
.....	- -
.....	- - - -
.....The lobby -	- -
.....	- - - -
.....	- - - -
.....	- - - -
.....	- - - -
.....	- - - -
.....	- -
.....	- - - -
.....	- - - -
.....	- - - -

.....	- - -
.....	- - -
.....	- -
.....	- -
.....	- - -
.....	- -
.....	- - -
.....	- -
.....	- -
.....	- -
.....	- -
.....	- -
.....	- -
.....	- -

الباب الرابع: دراسة ميدانية لمستشفيات محلية وعالمية

:	
..... ()	- -
.....	- -
.....	- -
.....	- -
.....	- -
.....	- -
.....	- -
.....	- -
.....	- -
.....	- -
.....	- -
.....	- -
.....	- -
.....	- -
.....	- -
.....	- -

:

Royal Alexandra Children's Hospital :

- -

..... - -

..... - -

..... - -

..... - -

..... - -

..... مستشفى Royal Alexandra - -

..... **Evelina Children's Hospital** - -

..... - -

..... - -

..... - -

..... - -

..... Evelina - -

:

..... النتائج والتوصيات

..... المراجع

٢٣٩ الملخص باللغة العربية

٢٤٥ الملخص باللغة الإنجليزية

فهرس الجداول

الصفحة	الموضوع	رقم الجدول
		- -
	-	- -
		- -
	:	- -
	-	- -
	:	- -
	:	- -
٧٩		١-١-٢
١٠٠		٢-١-٢
		- -
		- -
		- -

فهرس الأشكال

رقم الصفحة	الموضوع	رقم الشكل
		- -
		- -
		- -
	(GERCO – RoMAN- IATRIA)	- -
		- -
		- -
		- -
		- -
		- -
		- -
	" "	- -
		- -
		- -
	Children's Hospital of Pittsburgh	- -
	WakeMed	- -
	Nationwide Children's Hospital	- -
	Suzhou Children's Hospital	- -
		- -
		- -
		- -
		- -
	(Family Room)	- -
	(Pantry or Dining Room)	- -

		- -
		- -
		- -
		- -
		- -
		- -
		- -
		- -
		- -
		- -
		- -
		- -
	Louis Children's Hospital	- -
		- -
		- -
		- -
	Children's hospital in Chicago	- -
		- -
	Rady Children's Hospital	- -
		- -
	CHILDREN'S HOSPITAL EDINBURG	- -
	Dell Children's Medical Center	- -
		- -
		- -
		- -
	Fort Memorial Hospital Campus	- -

	The Royal National Orthopedic	- -
	Dell children Medical Center	- -
	Phoenix Children's Hospital	- -
	Children's Hospital of Eastern Ontario	- -
	Missouri Baptist Medical Center	- -
		- -
		- -
		- -
	(Mark best hospital)	- -
		- -
		- -
		- -
		- -
		- -
	DENVER CHILDREN'S HOSPITAL "Way finding "	- -
		- -
		- -
		- -
	Harbor California	- -
		- -
	Edinburg Children's Hospital	- -
		- -
	Sunrise Children's Hospital	- -
		- -
		- -

	Children's Hospital Westmead	- -
	UCSF Benioff Children's Hospital	- -
		- -
	Media wall	- -
		- -
		- -
		- -
		- -
	Benioff Children's Hospital	- -
		- -
		- -
		- -
		- -
		- -
		- -
		- -
		- -
	Phoenix (- -)	- -
	(LED) Children's Hospital	- -
		- -
		- -
		- -
		- -
		- -
		- -
		- -
		- -

		- -
		- -
		- -
	Ireland Children's Hospital	- -
		- -
		- -
		- -
	CHILDREN'S HOSPITAL AT MONTEFIORE	- -
		- -
		- -
		- -
		- -
		- -
		- -
		- -
		- -
	University of Chicago Children's Hospital	- -
		- -
		- -
		- -
		- -
		- -
		- -
		- -
		- -
		- -

المقدمة



:

)

.....

.(

.

"

"

.

.

)



:

() ()

:

-

)

(

()

-

:

-

-

:

:

:

-

-

-

:

■

■

■

■

الباب الأول

تطور نشأة المستشفيات وتصميمها

الفصل الأول

مقدمة تاريخية عن تطور الفكر التصميمي
في بناء المستشفيات

:

)

(

: Medicine at the ancient Egyptians المصريين

- -

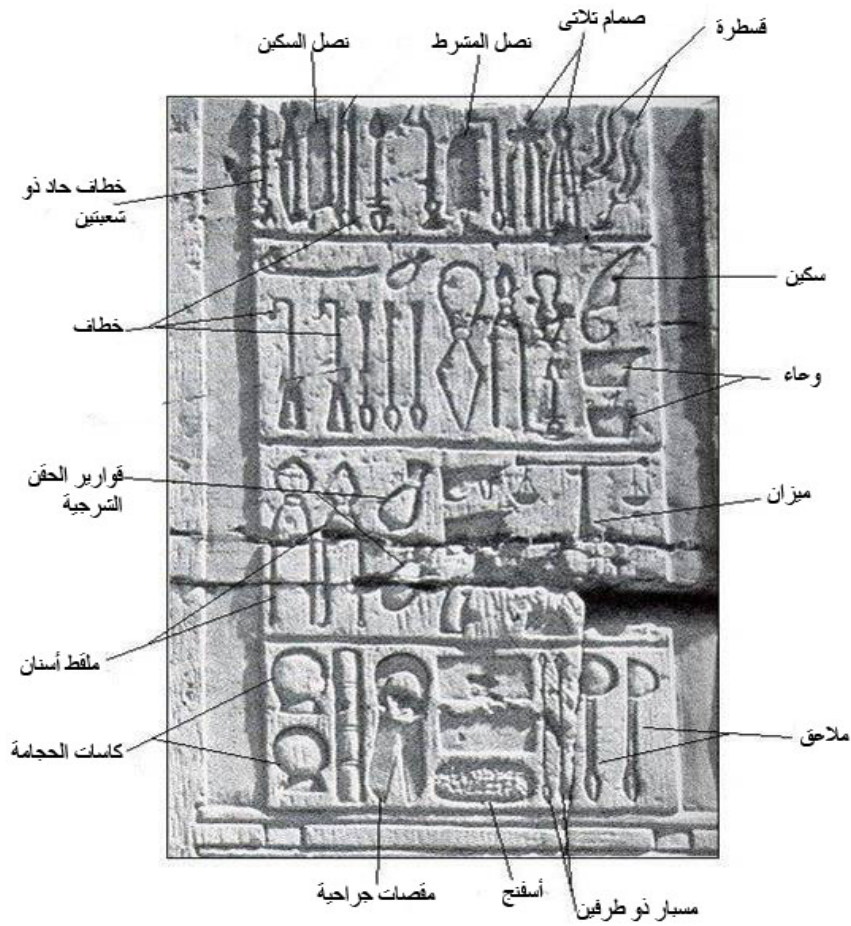

(- -)

"

"

"

"

-

-

-

-

-

-

-

-

-

-

-



(- -)

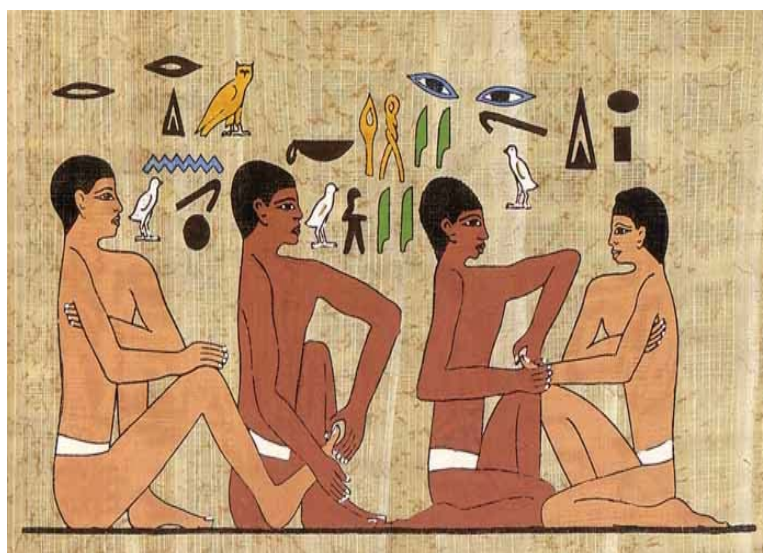

(- -)

:()

- -

:Hospitals in the Indian civilization

- -

(Cikista)

- -

Development of hospitals design in the west:

“Plastic Surgery”

- Garret , R. Hospitals-asystems Approach, st Ed. (Philadelphia: AVERACH publishers Inc, .p ,

- Rakich and Darr , K. Hospital organization and management nd Ed. (New York : SP Medical and Scientific Books,).p

:)

- "

"

-

-

(

-

-

-

-

-

-

-

-

:Greco ages

- - -

()

(GERCO – Roman- IATRIA)

"IATRIA "

(- -)

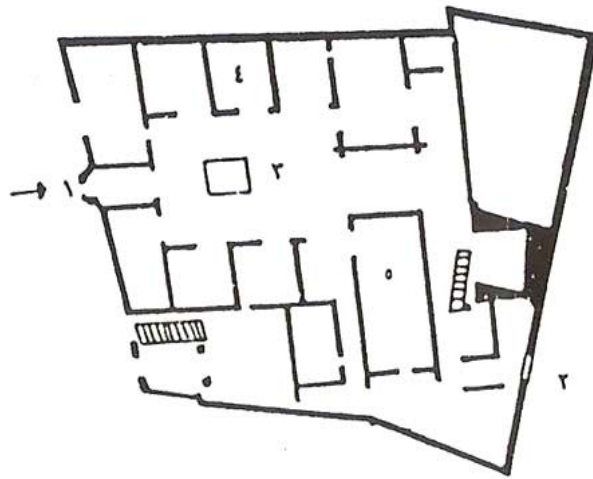

(GERCO – Roman- IATRIA)

(- -)

- -

- -

-

: Roman ages

- - -

()

-()

- -

-

()

:Christian ages

- - -

()

"XENODOCHIUM "

"Pavilion Wards"

(St- Jerome)

(- -)

(XENODOCHIUM)

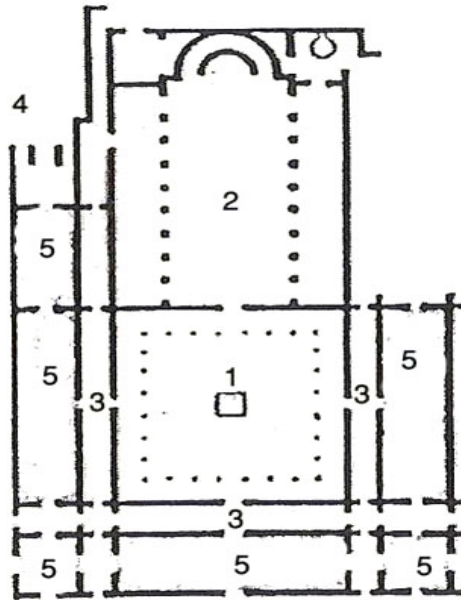

(- -)

-

-

-

-

: Renaissance

- - -

-

“Ospedal Maggiore”

(-)

(- -)

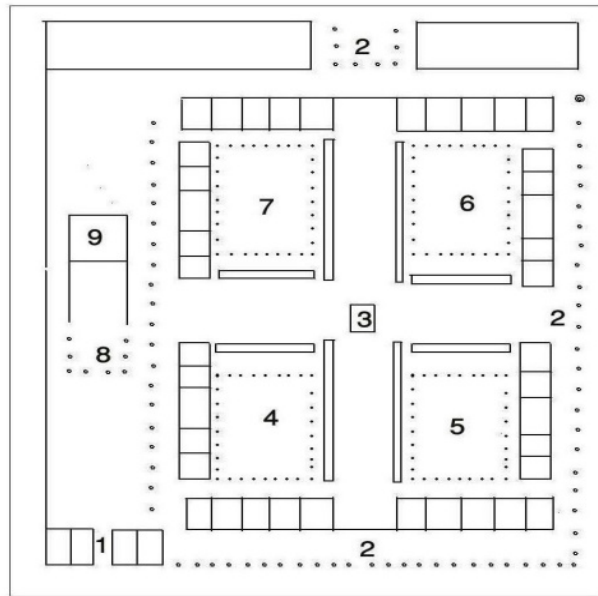

(- -)

-

-

-

-

-

-

-

-

-

- - -

Design for hospitals in the middle ages:

(Florence Nightingale)

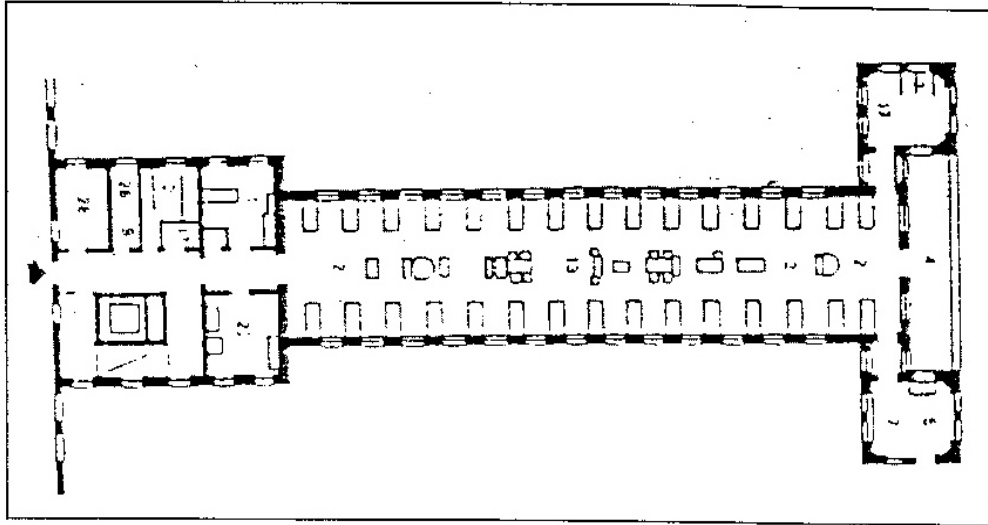

(- -)

-()

- -

- -

- - -

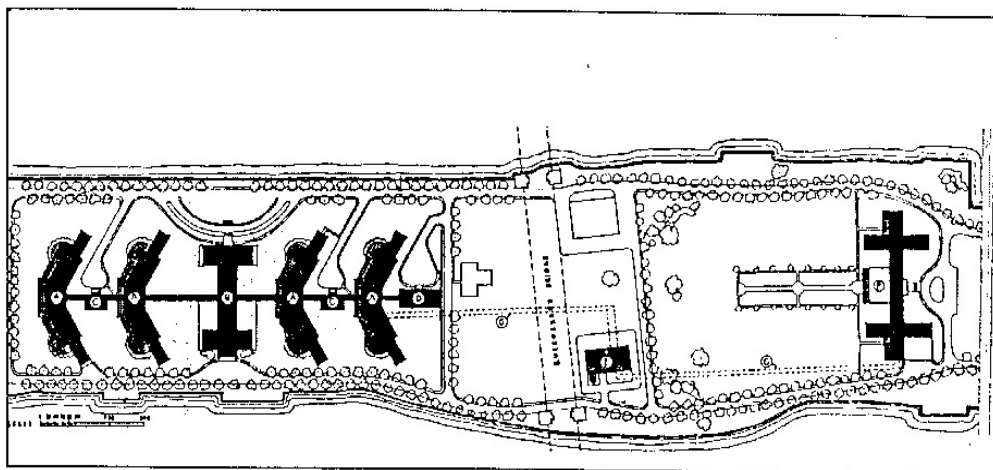

(- -)

()

History of hospitals in the Islamic State:

:"

()

:"

(-)

()

- - - - -
- - - - -
- - - - -

(-) .

:-

" "

" "

:-

-()

()

:

:

" "

- ()

- - -

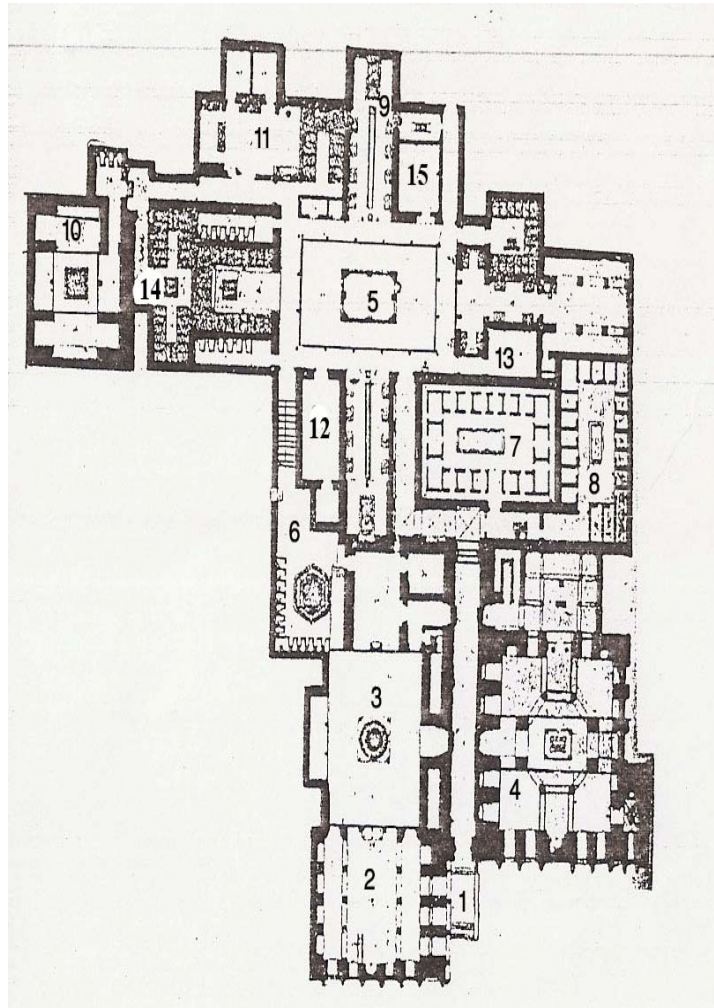

- - - -
- - - -
- - - -
- - - -

(- - -)

- - - -

:

- -

Theory Miasma

:

- -

- -)

(

“Mono blok”

- -()

- -

Globally construction history of children's hospitals

:

- ١- Children's Hospital Boston ١٨٦٩ -
- ٢- مستشفى أطفال المركز الطبي الأهلي بواشنطن ١٨٧٠ Children's Hospital national
Medical Center in Washington,D.C,
- ٣- مستشفى أطفال سانت ماري ١٨٧٠ St. Mary's Hospital for children
- ٤- مستشفى سي شور هاوس بمدينة أتلانتيك ١٨٧٥ Children's Hospital seashore house
Atlantic City
- ٥- مستشفى سانت كريستوفر بفلادلفيا ١٨٧٥ Christopher's Hospital for children,
Philadelphia
- ٦- مستشفى سانت لويس للأطفال ١٨٧٩ Louis Children's Hospital .
- ٧- مستشفى ميموريال للأطفال بشيكاغو ١٨٨٢ Children's Memorial Hospital
Chicago.
- ٨- مستشفى المركز الطبي بسينسيناتي ١٨٨٣ Children's Hospital Medical Center
Cincinnati,

- - -

Local Construction history of children's hospitals:



(- -)



" " (- -)

الفصل الثاني

مستشفيات الأطفال

(المفهوم - التصنيف - أسس التصميم)

١-٢-١ تعريف المفهوم العام للمستشفى:

"

:The concept of Children's Hospital

- -

١ - سلسلة التقارير الفنية لمنظمة الصحة العالمية ، ١٩٧٥ ، رقم ١٢٢ ، ص ٤
٢ - منظمة الصحة العالمية ، إدارة المستشفى ، سلسلة التقارير الفنية رقم ٣٩٥ ، جنيف ، سويسرا ، ١٩٨٠ ، ص ٦،٧

٣- Gish, Oscar - Guidelines for health planners: The planning and management of health services in Developing Countries- ١٩٧٧- p٤٢,٤٥

(- -)

-

:

- - -

: Classification

- -

:

:Owner

- - -

:Types

- - -

.()

-

()

-

-

-

-

- bridgman,R.F., The importance of legislation and Adminis For Medical Facilities ,with special reference to developing tration countries , in Approches to planning and design of health facilities- - p

(- -)

-

()

: location

- - -

(- -)

: Size of the hospital

- - -

:Design stages of the hospital

- -

-

-

-

-

-

: Hospital site

- -

المستشفى

- - -

:Way to get to hospital

- - -

-
-
-

-
-

-

-

:Hospital direct

- - -

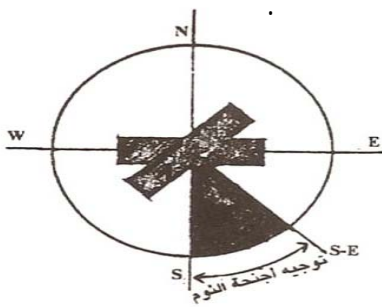

(- -)

للمستشفى:

يمكن تقسيم عناصر المستشفى وظيفيا إلى ٦ أقسام أساسية هي:

- ١- وحدات التمريض
- ٢- أقسام الكشف والعلاج

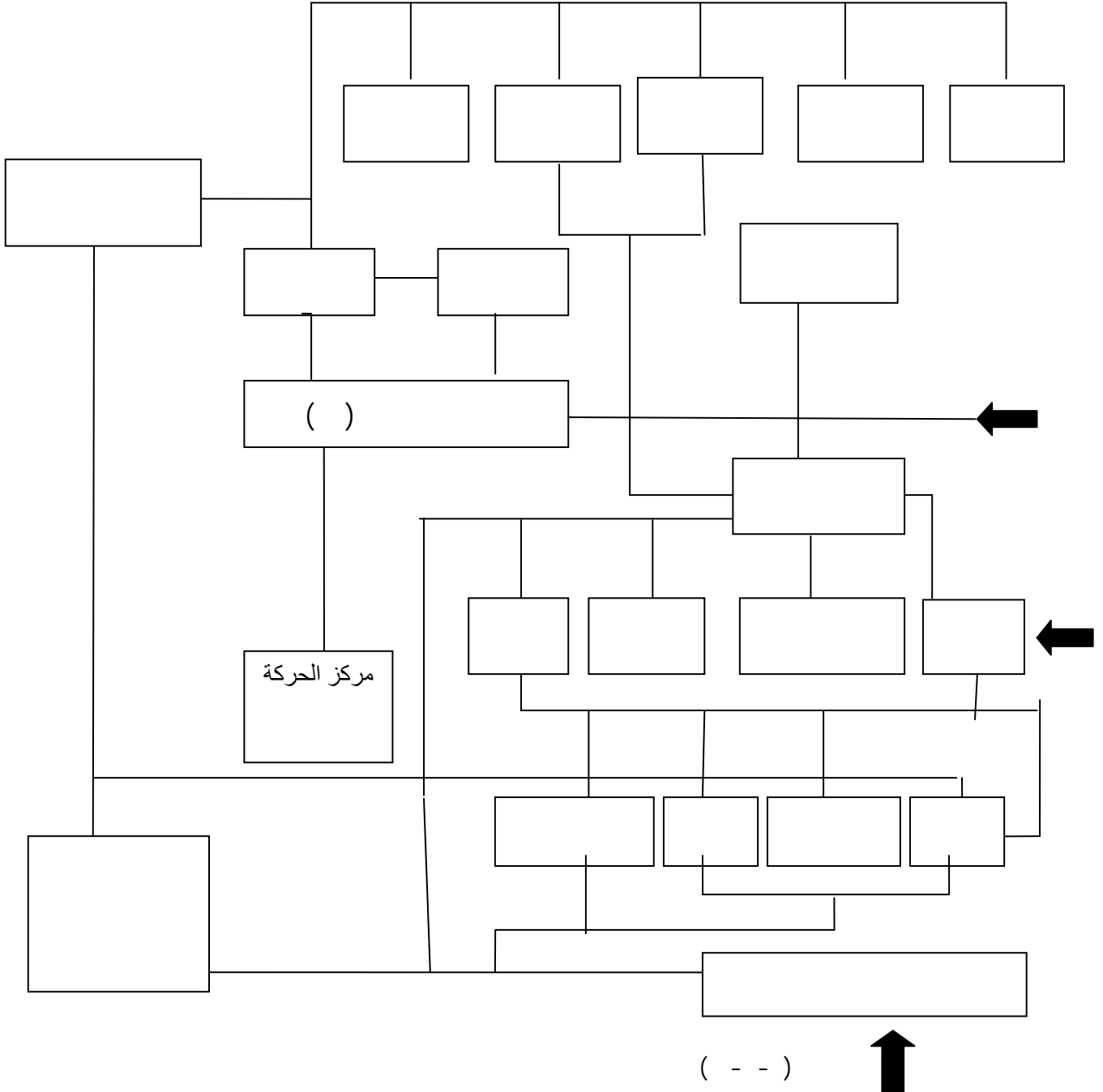

(- -)

-

- -

Basic considerations in the design:

:

١-٧-٢-١ مشاركة المستخدمين :User participation

- - -

human dimension in the design :

- -)

.(...

-

: Susceptibility to an extension

- - -

- - - - () - - -

: Flexibility

- - -

(system of construction)

١-٢-٨ الإعتبارات التصميمية لمستشفى الأطفال:

):

^١ - محمد ماجد خلوصى - المستشفيات والمراكز الصحية والاجتماعية - مرجع سابق - ص ٧

^٢ - عمر عبد القوى - عمارة مختلفة للطفل - مقال مجلة عالم البناء - عدد ١٢٠ - ١٩٩١ - ص ٢٣

(- -)

-

-

-

-

-

-

-

-

-

-

"Lobby"

)

(

- Komiske, Bruce King - Designing the World's Best Children's Hospitals The Future
of Healing Environments- Volume - Iamges Publishing , Austraila - page



Children's Hospital of Pittsburgh

(- -)



WakeMed

(- -)

-()

↳ <http://creakysites.wordpress.com/2009/09/28/news-innovative-hospital-design-patient-centered-care-childrens-hospital-of-pittsburgh/>

↳ www.pervisioncompany.com/case-studies/wakemed-fundraising-advantage/

(- -)

-

:

- -

:

-

-

-

-

-

-

:

- -

Children aged (0-12 months): (-)

- - -

- Series, Stephen A.Kliment- Building type basiscs for health car facilities –
published in Canda- p -

(- -)

-

: (-)

- - -

: " "

•

•

•

•

(-)

- - -

•

•

•

•

•

•

:(-)

- - -

•

•

•

•

•

•

•

The role of design in reducing the chances of transmission:

:

(Environment Design)

Exploit the potential visual

-
-
-
-
-

- Zakia Hassan Shafey , B.Sc.(children s hospital) University College , London
- Tourism Ministry ; Requirements for Eco-lodge design in Egypt tourism
development Authority, Cairo, .p.

^٣ - محمد جمال الدين الفندى - طبيعيات البحر وظواهره - مكتبة النهضة العربية - القاهرة - ص ٢

(- -)

-

: Importance of the nature

- - -

% -



Nationwide Children's Hospital

(- -)(- -)

Sushi Children's Hospital "

- www.newswise.com/articles/nationwide-childrens-hospital-to-break-ground-in- -for-third-research-facility-as-final-piece-to-expansion-plan

Υ- <http://www.archibaseplanet.com/blog/view/3274.html>

(- -)

-



(- -)

)

-

-

⁴ - <http://images.icnetwork.co.uk/upl/wirralnews/dec2011/2/9/single-room-on-maternity-ward-at-wirral-women-and-children-s-hospital-260-022372127.jpg>

(- -)

-

:

: Ergonomics

- -

- - -

(Erg)

Ergonomic

(Nomic)

: Concept of Ergonomics

- - -

"

"

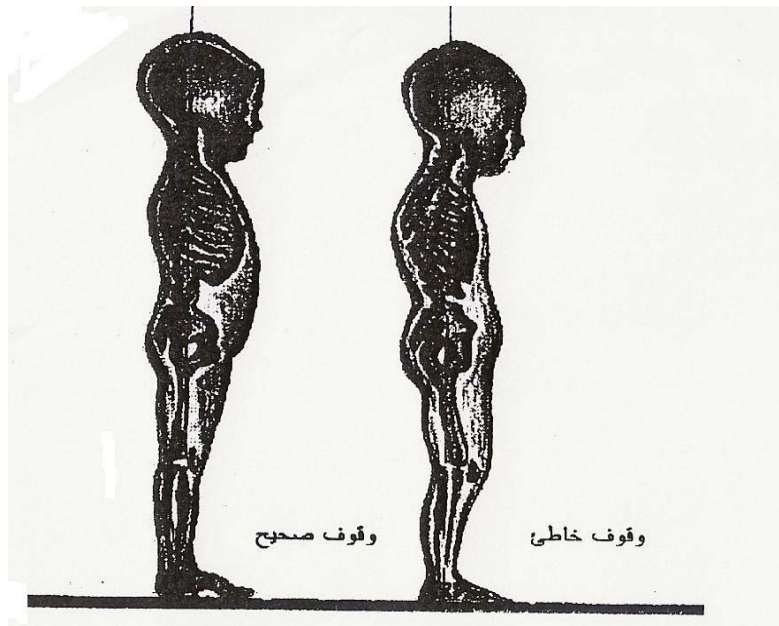

(- -)

:

- - - - -

(- -)

-

:

- - -

-
-

(- -)

" "

-
-
-

:Anthropometry

- -

(Metrikos -)

()

:

:

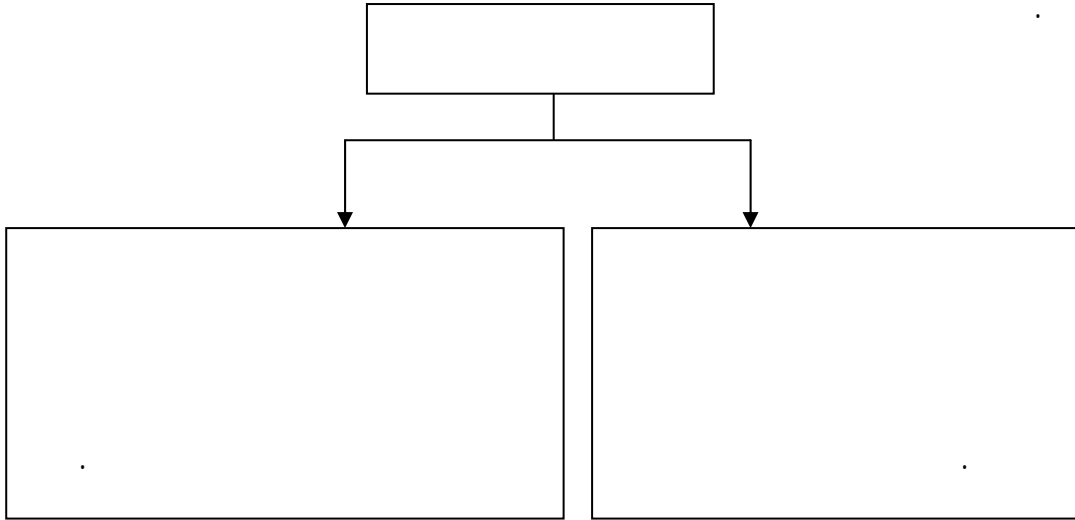

.Individual design

:

•

linear Dimenions

Dimenions Circumferential

Dimensions Curvilinear

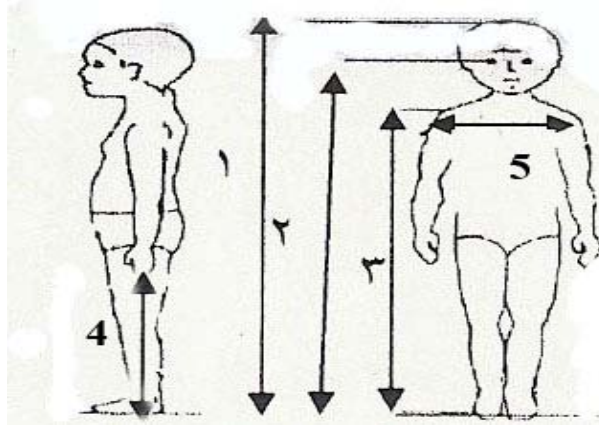

(- -)

()	()	()	()	()		
.			.			
.		
.		
.		
.		
.		
.		
.		
.		

:

-

-

-

-

-

-

-

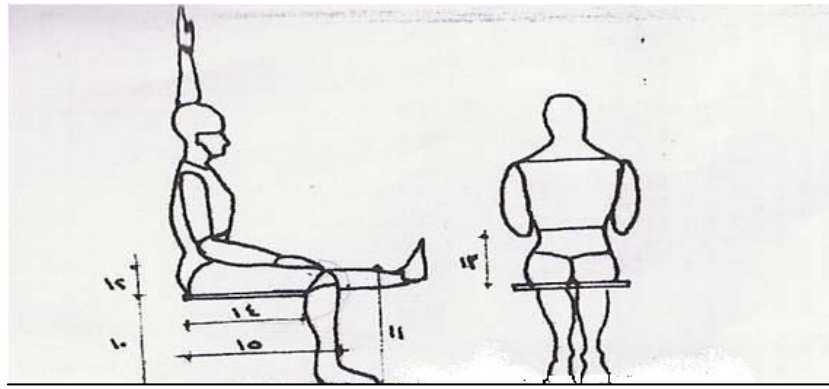

:

(- - -)

.		
.		
.		
.		
.		
.		

.		
.		
.		
.		
.		
.		

: - - -

الفصل الثالث

الإحتياجات السيكولوجية للطفل داخل
المستشفى

:

(.....- -) -
.(-) -
.(-) -
.

: Psychological needs

- -

:

-Maklin ،Jain - Hospital interior architecture Creating Healing Environments For Special patient populations – Van Nostrand Renhold company – USA – ١٩٩٢- pages

- Nightingale, Florance, “Notes On Hospitals”,Longman, Green,London

: The importance of the family

- - -



(- -)

١- Maklin ,Jain - Hospital interior architecture Creating Healing Environments For Special patient populations – Van Nostrand Renhold company – USA – ١٩٩٢- pages ١٢٨,١٢٩

٢ - http://www.christnerinc.com/img/projects/٩٠_٥٥٦_enlarged.jpg



(Family Room) (- -)



(Pantry or Dining Room) (- -)

El Camino Lucile Packard Children's Hospital¹

¹ - <http://www.millicanjones.com/healthcare-0^>.html>

: Social communication



(- -) (- -)



(- -)

١- Maklin Jain - Hospital interior architecture Creating Healing Environments For Special patient populations – Van Nostrand Reinhold company – USA , ١٩٩٢- pages ١٣١

- http://www.facebook.com/note.php?note_id=٣٢١٩٥٩٤٩٧٢٣٨

٢- http://thecenter.typepad.com/center_for_the_arts/٢٠٠٧/١١/hudson-vagabond.html

:Harmony



(- -)



(- -)

١- Maklin Jain - Hospital interior architecture Creating Healing Environments For Special patient populations – Van Nostrand Reinhold company – USA – ١٩٩٢- pages, ١٣١

٢- www.mca-architecture.com/portfolio/hope_children.html

٣- http://www.christnerinc.com/img/projects/٩٠٠٠٠_enlarged.jpg

:Comfortable

()

- - -



(- -)

:Access to outdoors

- - -

¹ - http://www.mmf.umn.edu/children/ch/2008/spring/adopt_a_rooms-MMF.cfm
- Maklin Jain - Hospital interior architecture Creating Healing Environments For Special patient populations – Van Nostrand Renhold company – USA – - pages - pages

: Importance of exposure to the sun, air

...

" "

“ out door play space”

: **Imagination** - - -

:

٢ - كنزى محمد الحلوجى - الأسس التصميمية للرعاية الصحية للأطفال فى المستشفى- مرجع سابق - ص ٨٦
- Maklin Jain - Hospital interior architecture Creating Healing Environments For
Special patient populations – Van Nostrand Renhold company – USA – - pages



(- -)



(- -)

http://orlandohealth.com/OrlandoHealth/Misc/ViewNews.aspx?WID=1&News_ID=694&PageFrom=M&pid=107
-http://lettherebelightphoto.blogspot.com/2011_07_01_archive.html

:Privacy

- - -

Designing for

(senses)

:security and safe

- - -

٣- Wayne ,Ruga ,” Designing For Senses” in” Healthcare Design”edited by Sara O.Marberry,Johnwiley&Sons,Inc,USA,١٩٩٧

٤- C.M, Deasy.in collaboration with Thomas E.laswell,”Designing Places For People A Handbook on Human Be havior For Achitects,Designers, and Facility Managers” The Whitney library Of Design, V.S.A - ١٩٨٥

Controlling environment:

(color clues)

1- NSH Estates Authorized by the Department of Health Gateway number: 1018 “
Improving the Patient experience” Friendly Health Care environment For Children and
Young people Tso (the stationery office) , London, 2006

:consideration of child scale



(- -)



(- -)

١- Maklin, Jain - Hospital interior architecture Creating Healing Environments For Special patient populations- USA - ١٩٩٢- pages ١٣١ -

٢- <http://www.virtualtoydrive.org/store/product.php?productid=٥٢٢&cat=٢١&page=٦>

٤- <http://uuldesign.com/home-decoration/bathroom/kid-bathroom-design-for-home-kindergarten-and-children-hospital/>



:Play

: - - -

: - - -

:

() -

() () -

1- Komiske , Burce king , Fache – Desgining the world best children hspitals – Iamges Publishing , Austraila 1999 – pages 10

:Play room

- - -

:

: Area for manual games اليدوية

- - - -

:Artworks area

- - - -

:Spaces allocated to the cubes

- - - -

-:Moving area

- - - -

: entertainment

- - - -

- - - -

/ -



(- -)

Louis Children's Hospital



(- -)



(- -)



(- -)

- (

)

-

-

² - <http://www.childrenshospital.org/gallery/index.cfm?G=09&page=10>

³ - <http://www.stlcommercemagazine.com/archives/november2007/construction.html>

⁴ - http://thecenter.typepad.com/center_for_the_arts/outreach

- <http://www.thematicdesign.com/rcProd.asp?id=30&c1=0>

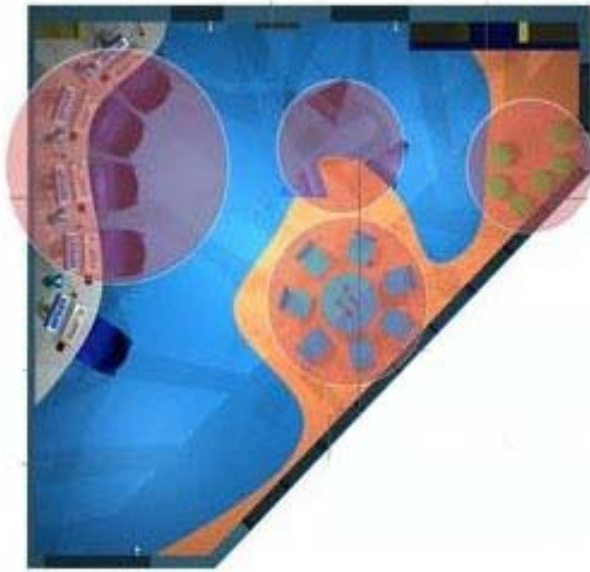

شكل (١-٣-١٩) المسقط الأفقي لحجرة اللعب بمستشفى

(- -)

Children's hospital in Chicago



(- -)

:

- - -

•

•

١ -http://www.designsrl.com/progetto.php?id_cat=٤&id=٢٨

-



•

•

.School-Age

•

•

•

•

:

- -

-

-

-

-

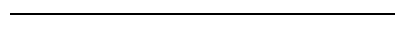

-

-

-

-

-Senda, Mitsure – Design of children s play environment – Published by McGraw-Hill

- - p

- ()

-

-



-

-

-

-

-

-

-

-

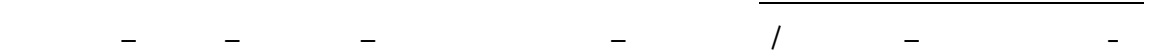

- Komiske, BruceKing - Designing the World's Best Children's Hospitals The Future of Healing Environments- Volume – Iamges Publishing , Austraila – page

الباب الثاني

مكونات العمارة الداخلية لمستشفى الأطفال

الفصل الأول

المعايير التصميمية للحيز الداخلي



:

: The exterior design

- -

-
- Komiske, Burceking Fache (Editor) –“Desgining the World Best: Children's Hospitals”, Images Publishing, Australia – pages
 - Komiske, Bruce King - Designing the World's Best Children's Hospitals The Future of Healing Environments- Volume – Images Publishing , Australia – page ,



Rady Children's Hospital



(- -) (- -)



(- -)

EDINBURG CHILDREN'S
HOSPITAL^٣ في تكساس

- - Komiske , Burceking Fache –“ Desgining The World Best: Children Hospitals”–
Iamges Publishing , Australia – pages

^٢ - <http://www.orchidsandonions.org/٢٠١٠/٠٨/١٩/rady-childrens-hospital-acute-care-pavilion>.

^٣ - <http://entertainmentdesigner.com/gallery/edinburg-children's-hospital/>.

Green spaces :

- -

- Komiske , Burceking - Designing the World's Best Children's Hospitals The Future of Healing Environments- Volume – Images Publishing , Australia – page ,

-Komiske , Burceking –“ Desgining The World Best: Children Hospitals”– Images Publishing Australia – pages



(- -)



(- -)

Dell Children's Medical Center



(- -)



(- -)

¹ - Komiske , Burceking - Designing the World's Best Children's Hospitals The Future of Healing Environments- Volume 2 – Images Publishing , Australia 2008– page 99

²- <http://www.jetsongreen.com/2007/12/first-leed-plat.html>

- <http://www.flickr.com/photos/tranquilityknots/>

[/in/photostream/](#)



(- - - -)



(- - - -)



(- - - -)



(- - - -)



(- - - -)



(- - - -)

- <http://www.greenroofs.com/projects/pview.php?id=>

:
: **Design of interior space**

- -
- - -

:internal Architectural elements

- - -

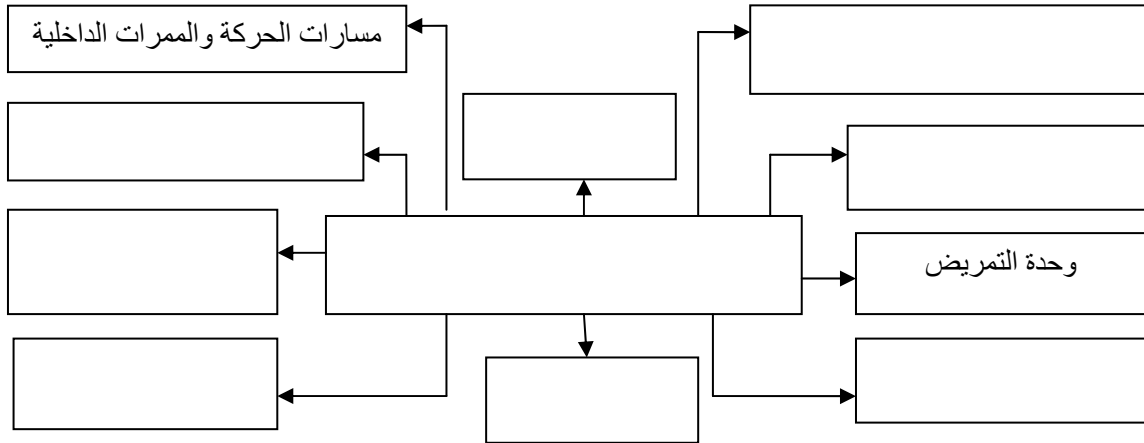

(- -)

:External entrances

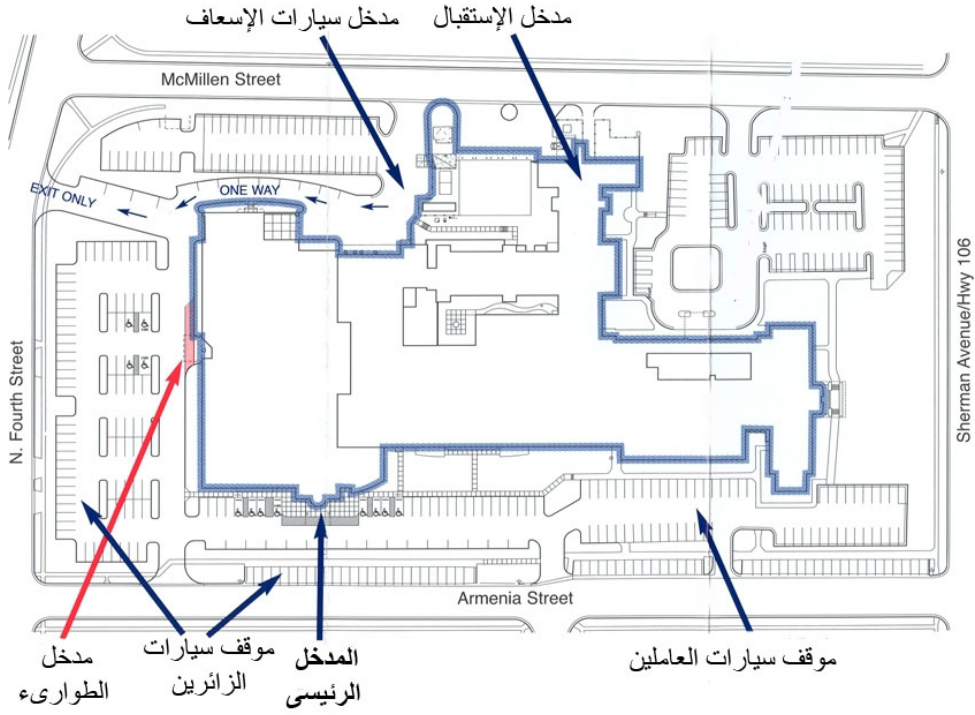

Fort Memorial Hospital Campus

(- -)

<http://www.forthhealthcare.com/media/images/hospital-parking-and-entrances.jpg>



شكل (١١-١-٢) المسقط الأفقي لمنطقة الإستقبال بمستشفى The Royal National Orthopedic^١

^١ - <http://www.rnoh.nhs.uk/about-the-rnoh/bolsover-street/the-facilities>

-
- -
: The lobby - - -

" counter"

...

: - - -

: security room -

: Information Counter -

:Main Reception Counter -

()



Phoenix (- -)

Children's Hospital



(- -)

Dell children Medical Center^y

- http://www.glumac.com/greenResourcesnewsletterNewsletter_Issue.html

^z - <http://www.bogoraya.com/interior-design/interior-design-phoenix-childrens-hospital/>



: Waiting areas

- - -

- Komiske, Bruce King - Designing the World's Best Children's Hospitals The Future of Healing Environments- Volume – Images Publishing , Australia – page ,

- 2

: Waiting seats

-:

-
-
-



شكل (١٥-١-٢)



(- -)

يوضحان نموذج لمقاعد الإنتظار بمستشفى^١ Children's Hospital of Eastern Ontario و مستشفى^٢ Missouri Baptist Medical Center

E

P

P-E=S

S

. P-E=S

^٢-www.applieddesigns.ca/children/index.htm

-www.missouribaptist.org/?id=٤٦٥٩&sid=٩



•

•

()

()

•

:

- - -



"nursing mothers"

:

- - -

-

:Toilets

- - -

:

)

- - - - - (-

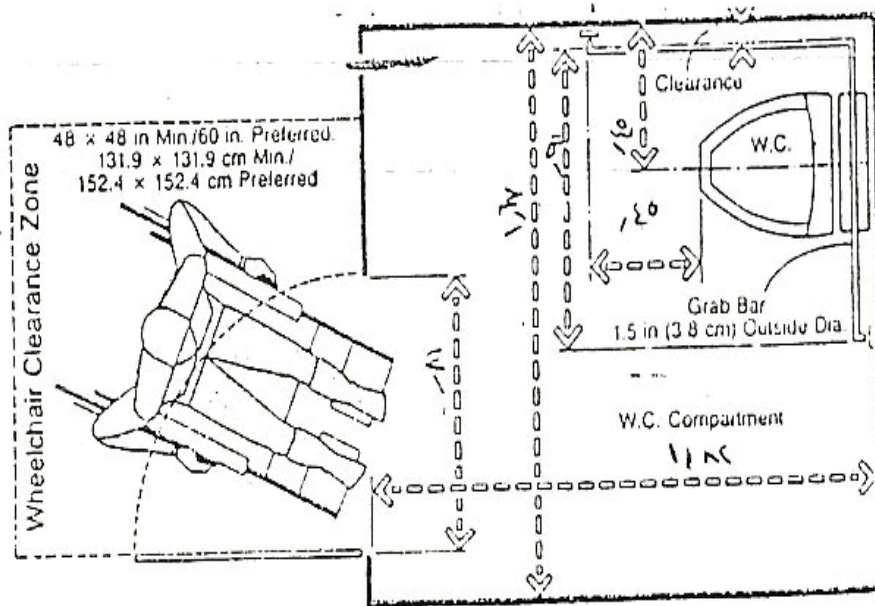

(- - -)

- Maklin Jain - Hospital interior architecture Creating Healing Environments For Special patient populations – Van Nostrand Reinhold company – USA – 1992 - pages 347

- Julius Panero, Martin Zlink, Human Dimension, Interior Space, Whitney Library of design, p

:Emergency

.....
" cubicles "



(Mark best hospital)

(- -)

: Internal Traffic

- -

(cul-de-sac)

:

- - -

()

:

- - - -

-

:

-

-

· · × ·

-

-

- -

- -

- -

- - - -

:corridors

()

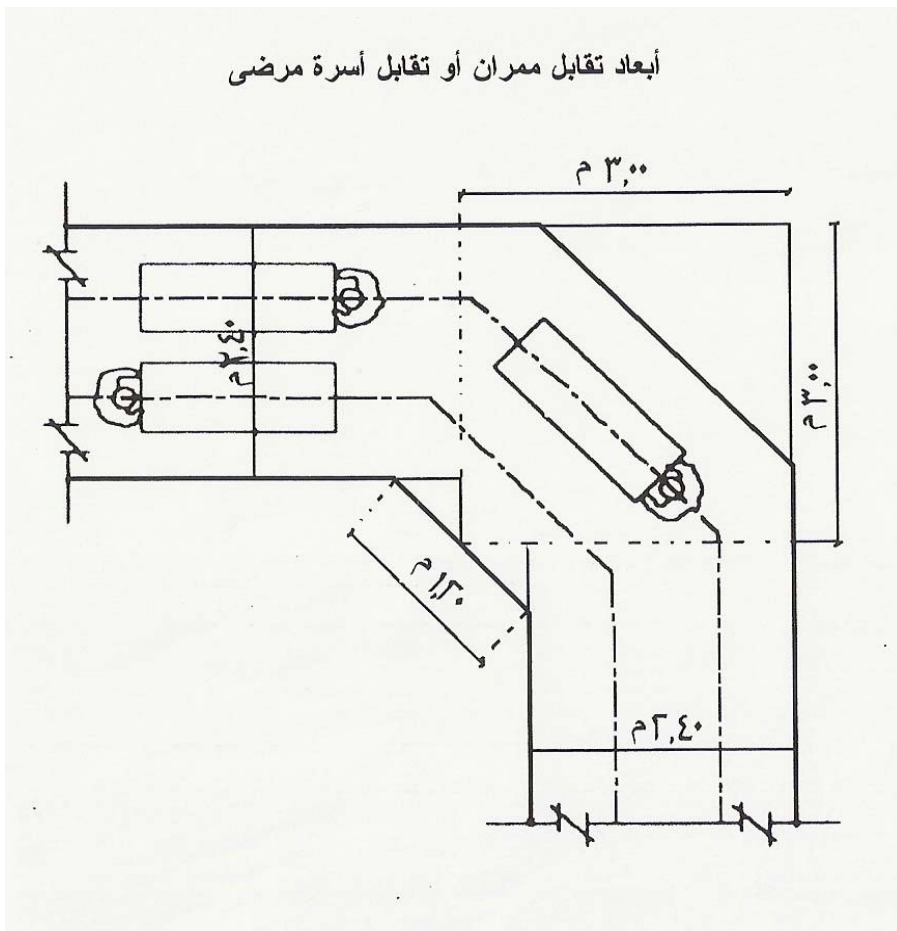

(- -)

-

(- -)

	.	
	.	
	.	

- - -

:

-

-

-

:Elevators

- - - -

-

-

()

.()



-

-

-

-

-

-

(x)

-

()

-

x

-

()

-

:

:

•

•

-

-

-)

-

-

-

-

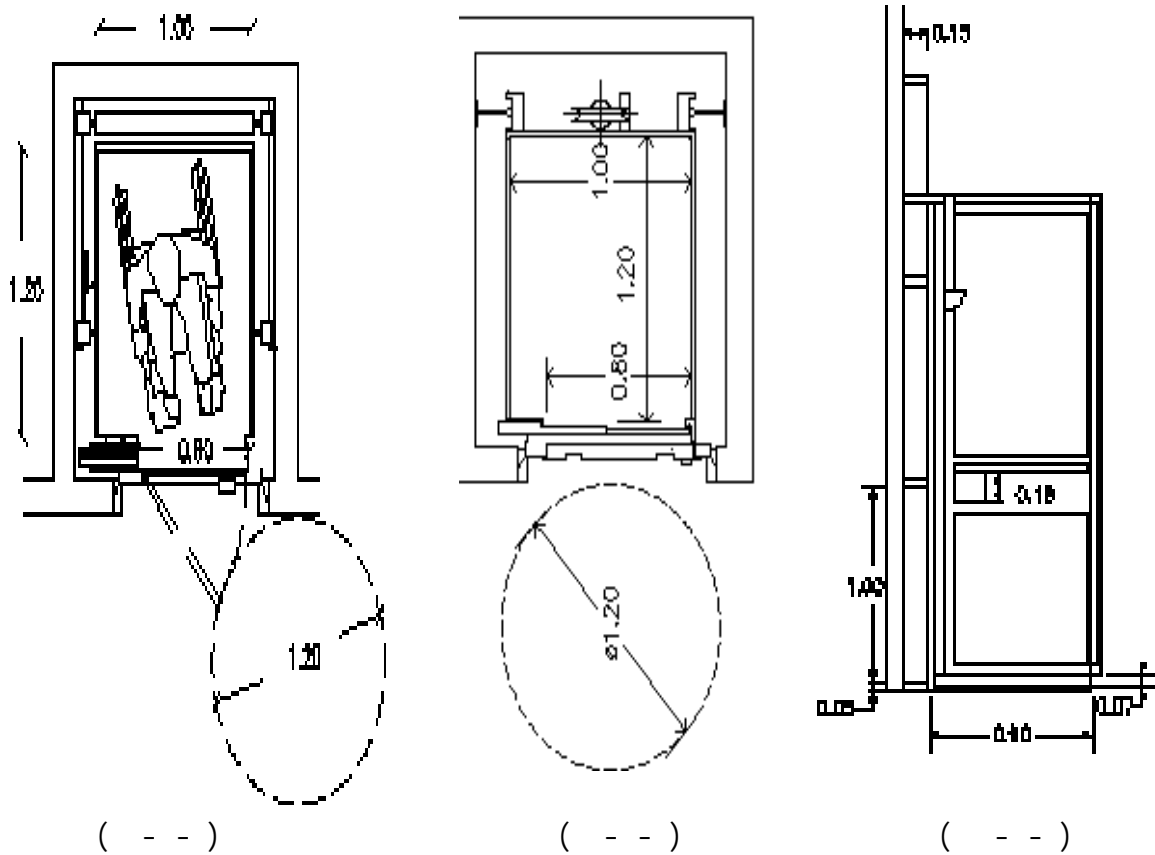

-<http://www.bibliocad.com/library/people-with-disabilities/wheelchair-ramps--special-elevators/>

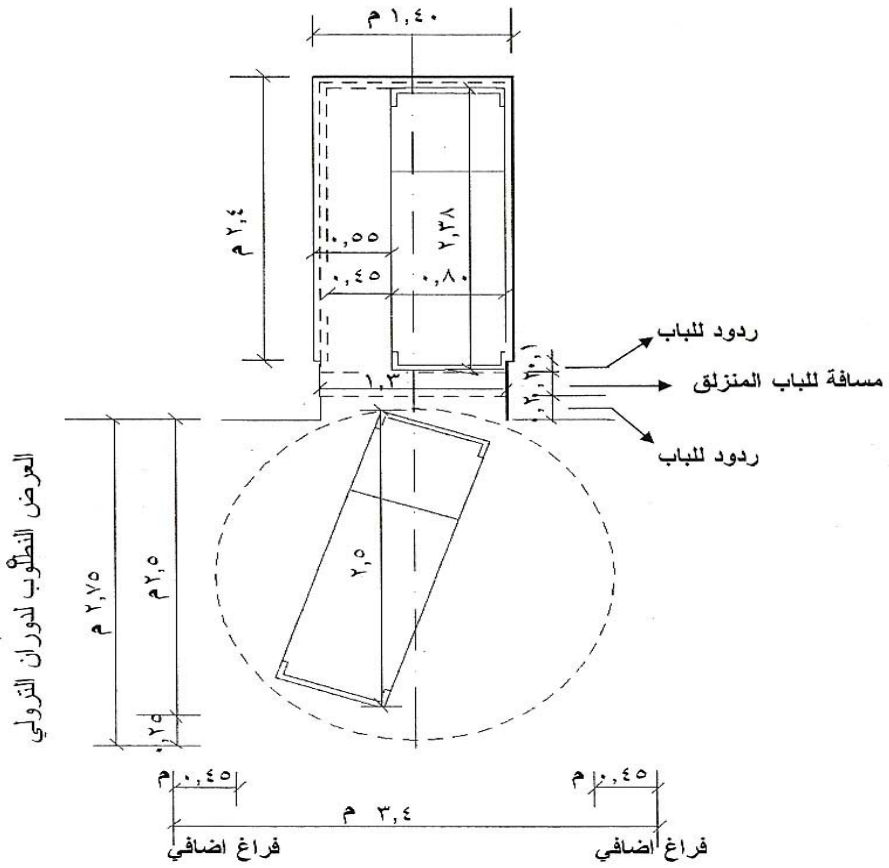

(- -)

: Stairs

- - - -

:

-

-

-

- ٢

-

-

-

-

-

-

-

-

-

-

-

-

-

-

-

-

-

-

عرض البسطة الذي يسمح بدوران المرتبة

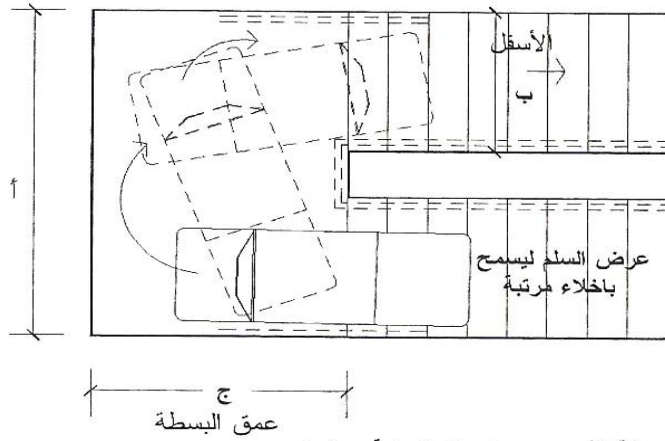

أ - عرض البسطة الذي يسمح بدوران المرتبة = ٢,٨

ب - عرض القلبة = ١,٢

ج - عمق البسطة = ١,٩٥

وفي حالة الرغبة في مرور شخص بجوار هروب المرتبة تكون الأبعاد كالتالي :

أ - عرض البسطة الذي يسمح بدوران المرتبة = ٣,٨

ب - عرض القلبة = ١,٨

ج - عمق البسطة = ١,٣٥

(- -)

:

- - - -

-

-

-

:

-

-



:slope

:Handrail الكوبستات

:The edges of the slope حواف المنحدر

: way finding

- ٤-٧-١-٢

"way finding"

"way finding"



(- -)



(- -

بوضوح استخدام أسلوب "Way finding" بمستشفى DENVER CHILDREN'S HOSPITAL لتسهيل الحركة للزائرين والوصول إلى الأماكن بدون تشتت^٢

:Direct

- - - -

:Specialization

ج - - - -

()

- Komiske , Burce king – Desgining the world best children hospitals – Image Publishing , Australia – pages,
٢-http://www.inktankdesign.com/portfolio.php?cat=environment

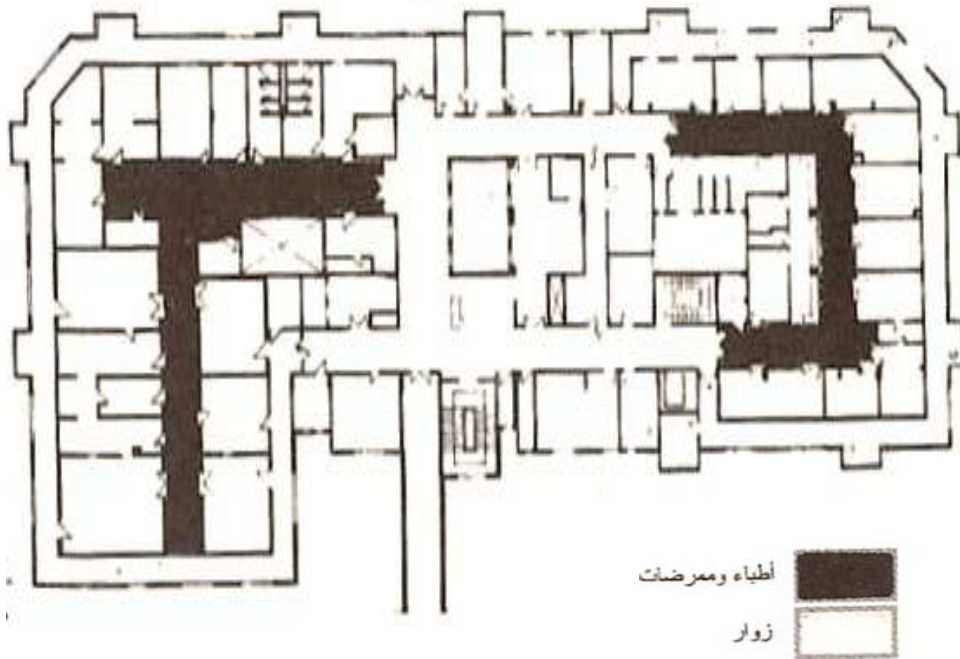

(- -)

:Capacity - - - -

:Confirm the intersections ٥-٤-٧-١-٢ تأكيد التقاطعات والعناصر الهامة

: Hospital interior corridors

Vista

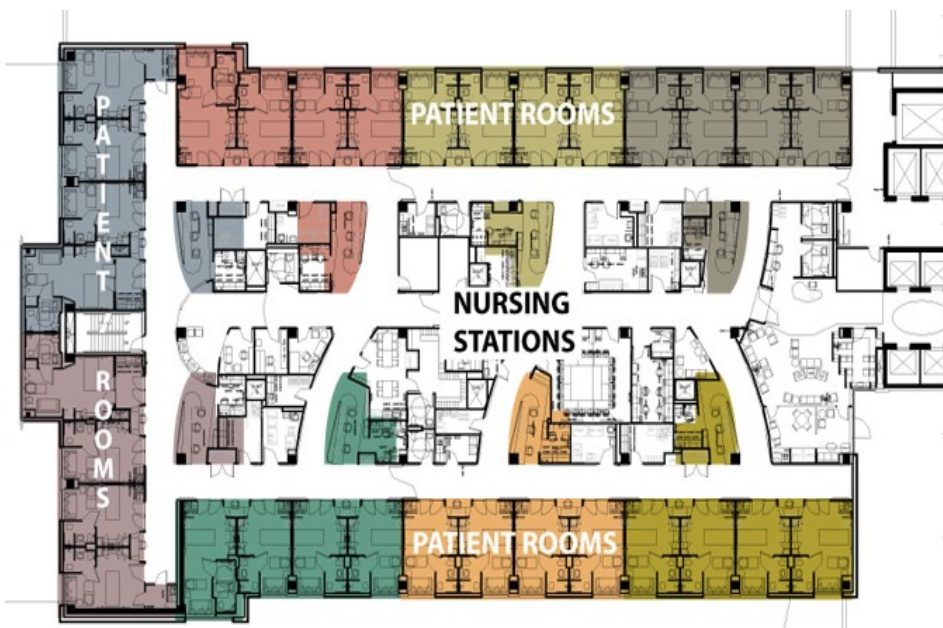

(- -)

١ - على رأفت - البيئة والفراغ - مرجع سابق -ص٤٠٧،٤٠٩:٤٠٦،٤٠٤،٣٩٤
٢ -http://www.christnerinc.com/img/projects/١٦_٧١_enlarged.jpg

-

-

-

-

-

-

-

-

-



Harbor California



(- -) (- -)



(- -)



(- -)

Edinburg Children's Hospital¹

Children's Hospital of
Philadelphia

¹ - www.muralenvironments.com

² - <http://www.focusegd.com/edinburg.html>

³ - [http://www.thelightingpractice.com/projects/childrens-hospital-of Philadelphia/](http://www.thelightingpractice.com/projects/childrens-hospital-of-Philadelphia/)

- (patient space)
- (- - - -)
- staff space
- - - - -



شكل (٢-١-٣٤) محطة التمريض بمستشفى Sunrise Children's Hospital^٢

^١ - وليد عبد المنعم عبد القادر – المتطلبات التصميمية في المستشفيات العامة – مرجع سابق ص-١٦
^٢ - <http://sunrisechildrenshospital.com/our-services/picu.dot>

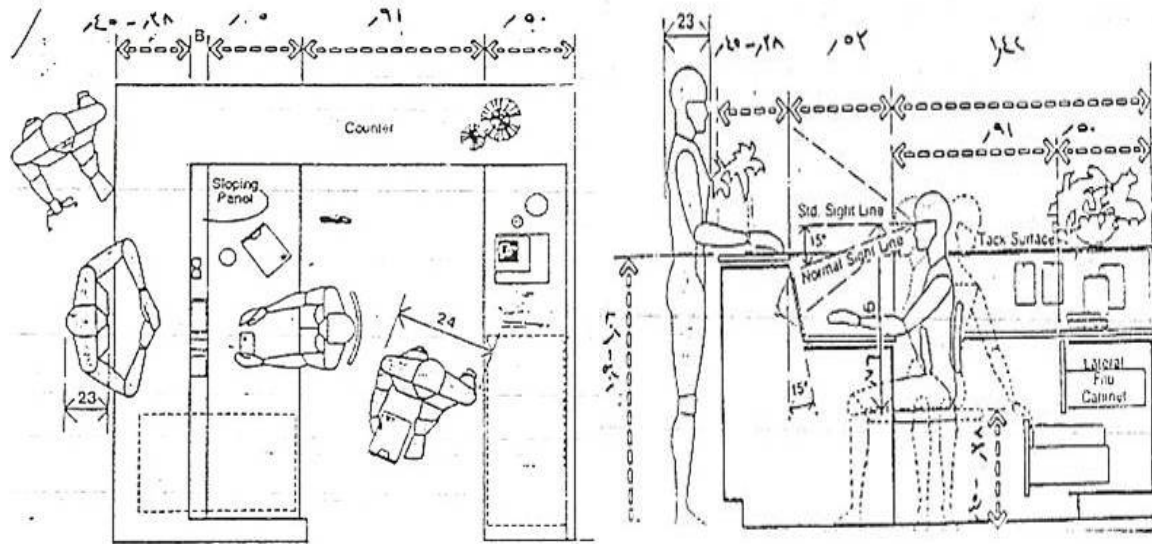

(- - -)

(- - -)

- Julius Panero, Martin Zlink, Human Dimension, Interior Space, Whitney Library of design, , p



Children's Hospital Westmead

(- -)

- Maklin Jain - Hospital interior architecture Creating Healing Environments For Special patient populations – Van Nostrand Reinhold company – USA – 1992 - page

<http://www.govarch.commerce.nsw.gov.au/projects.asp?PT=1&SI=1&PD=1&CP=12>



UCSF Benioff Children's Hospital

(- -)

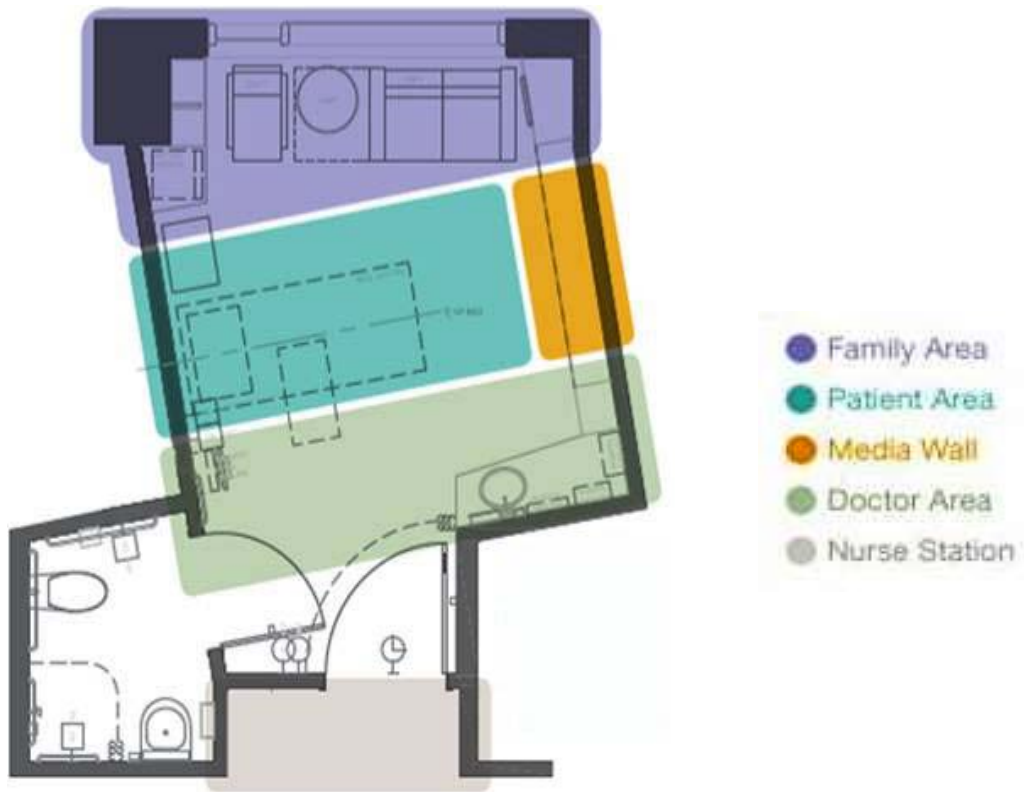

(- -)

1- <http://missionbayhospitals.ucsf.edu/facilities/childrens-acute-care-patient-room.php>



Media wall (- -)



(- -)

<http://missionbayhospitals.ucsf.edu/facilities/childrens-acute-care-patient-room.php>

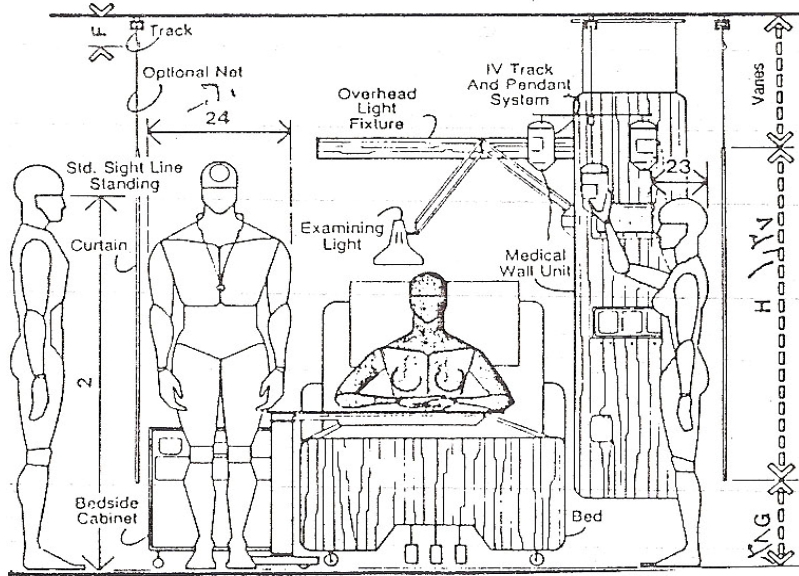

(- -)

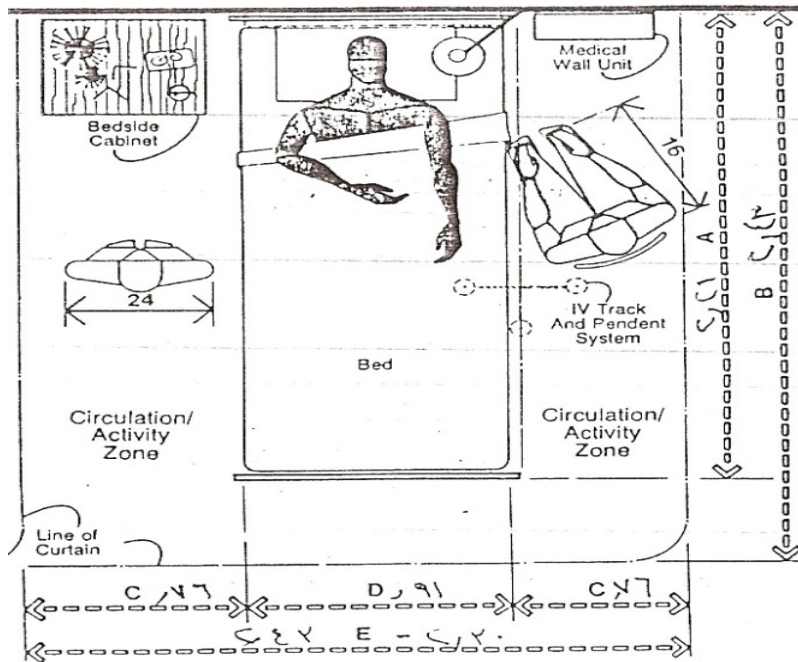

(- -)

-Julius Panero, Martin Zlink, Human Dimension, Interior Space, Whitney Library of design, p ,



: - - -

:

-

-

-

-

:

- - -

:

-

-

-

Garb-bar

-

.Toilet Paper holder

-

-

-()

- / -)

-

-

- - ::

-

-

-

-

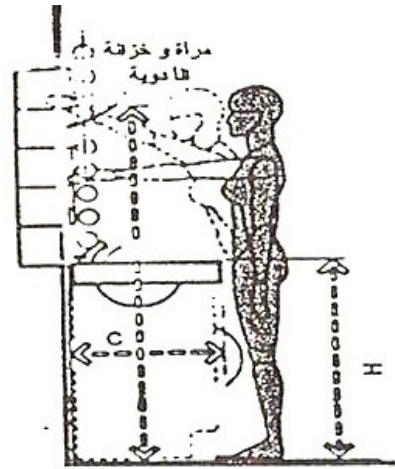
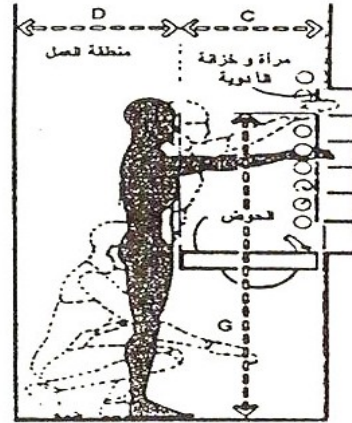
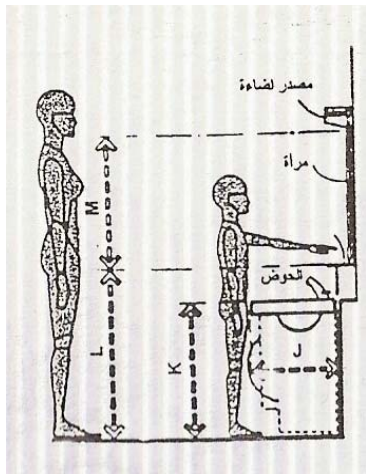
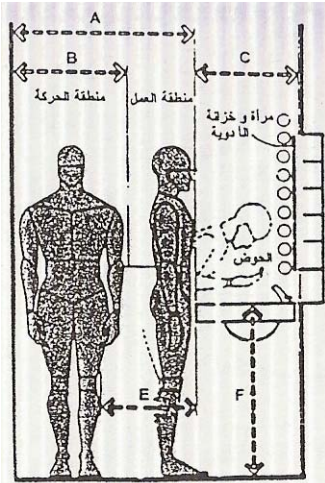

H	-	.	.
I			.
J	-	.	.
K	-	.	.
L			.
M	-	.	.

A			.
B			.
C	-	.	-
D			.
E			.
F	-	-	.
G			.

(- -)

-



:Outpatient

- -

()

:

- - -

:

:The reception

- - - -

:Pharmacy

- - - -

-

-

:Doctors Rooms

- - - -

- - -

- - -

:Exam Room

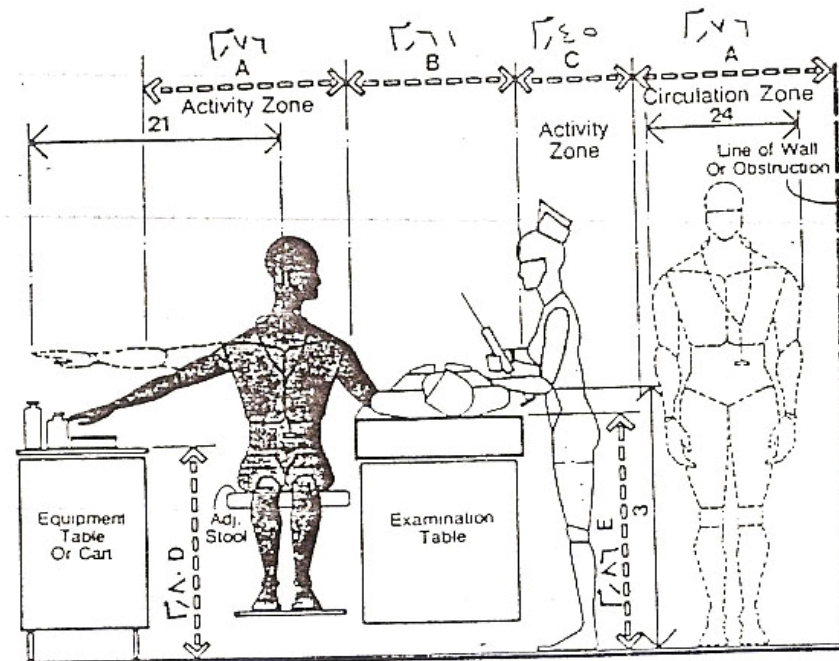

(- -)

- Julius Panero, Martin Zlink, Human Dimension, Interior Space, Whitney Library of design, , p

-

:Treatment rooms

- - - -

-

-

-

-

-

-

-

:

- - - -

-

-

-

)

.(

-

-

-

-

-

-

-

-

-

-

-

-

:

--

-

-

-



Benioff Children's Hospital

(- -)

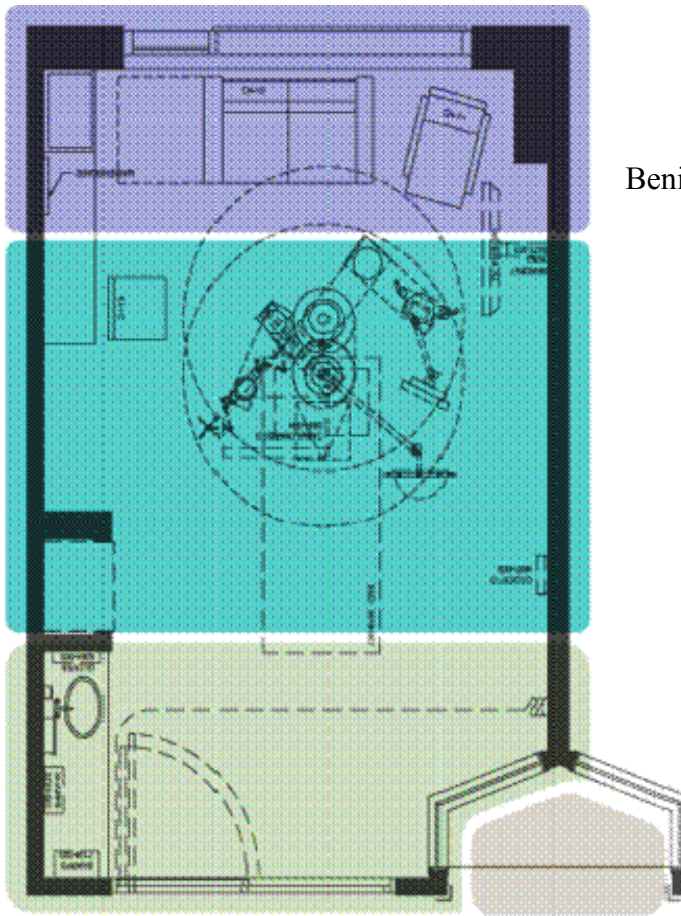

(- -)

Benioff Children's
Hospital

- Patient Zone
- Family Zone
- Staff Zone
- Charting Zone

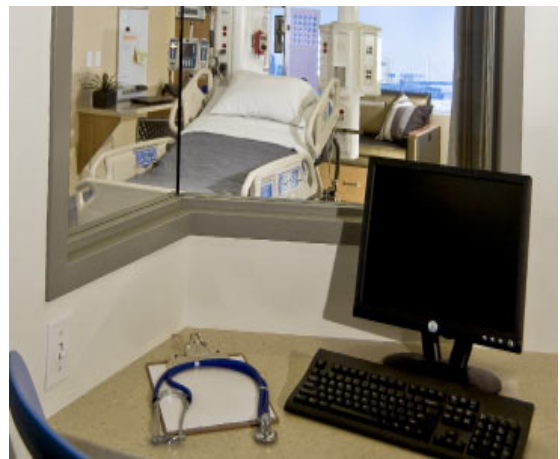

(- -)

1) - <http://missionbayhospitals.ucsf.edu/facilities/childrens-intensive-care-unit-patient-room.php>

١٠-٣-١-٢ : Laboratory and radiology المعامل والأشعة

: operations room

% -

^١ - سامح سيد شاذلى - مسارات حركة الإمدادات والشبكات العامة كأحد المؤثرات على تصميم المستشفيات - مرجع سابق - ص ١١، ١٢

(CRI)



(- -)



(- -)

¹ -David R.porter- Hospital Architecture For Design and Renovation-p¹ •
² -<http://www.heartatchildrens.org/cardiac-hybrid-or.php>



(- -)

<httpwww.hpnonline.cominside>

-OR-LIGHTS.html

الفصل الثاني

عناصر إظهار العمارة الداخلية لمستشفى
الأطفال

-



: light - -

- -

Outdoors

Indoors

: Lighting and light - - -

: Shadow and light - - -

: - - -

۱۳۹

- - - -
- - - -
- - - -
- - - -



:

:

•

:

-

-

-

-

•

-

•

()

(-)

-S.O.S

-

-)

-

-

-

-

-

-

-



-
-

:Control of natural lighting

- - -

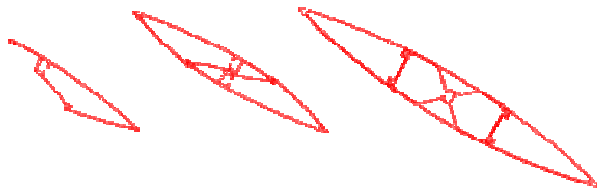

5

VERTICAL
ORIENTABLE BLADES

HORIZONTAL
ORIENTABLE BLADES



(- -)

: Industrial lighting

- - -

:

-
-

-

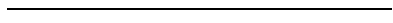

-

-

-S.O.S

<http://nodals.com/Site/Archi.sunbreaker.html>



-
-
-
-

(- -))

	lux	lux	
:			
	-		
:			

: Using Colored lighting

- - -

"

(Jaundice)

()

(Bilirubin)

-

-

-

-

-

-

-

:

- - -

-

:

- - -

-

-

-

-

-

-

-

-

:Lighting corridors

- - - -

:Emergency lighting

- - -

:

- - -

•

•

¹ -www.almasurgical.com/minor.htm



-

()

•

•

•

•

•

•

(Dimmer)

:

- - -

-

-

-

-

- -

- -



(- -)



(- -)

(- -)

١ -Isadore Rosen Field,Hospitals Integrated Design, p.٣٠١,٣٠٢

٢-http://livedesignonline.com/architainment/historic_boston_led_lighting_٠٥٣٠٠٧/

٣-<http://besthomegallery.com/interior/colorful-interior-design-of-queen-elizabeth-children-hospital/>

٤ - JAMA,Regulations of Acceptance of Ultraviolet, Lamps For Disinfecting Purpose

(CRI)



(- -)



(- -)

-)

Phoenix (-
Children's Hospital
(LED)

:color - -

: Psychological impact of color اللون - - -

(-)

: Color and movement trends - - -



:

- - -

-

-

-

-

-

- - -

Organic and therapeutic effect of color:

) (-)

(

- - - - -



:Radiotherapy color

- - -



Le docteur Prescrit la couleur

Podolosky "

"

(- -)

-	
-	
.	
.	
.	
-	

:

- - -

-

.()

- - - - -



:

-

:

:

- - -

•

•

•

•

•

()



-

-

-

-

-

-

-

-



(- -)



(- -)



(- -)



(- -)

العمليات

- - -

Relationship between Color and operations room:

- <http://benenatedesign.blogspot.com/> / / childrens-hospital-of-atlanta.html
- ٢- <http://www.thechildrenshospital.org/virtualtour/Photo-Gallery/index.aspx#>
- <http://www.thechildrenshospital.org/virtualtour/Photo-Gallery/index.aspx#>

blue-green

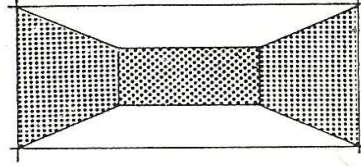

أ

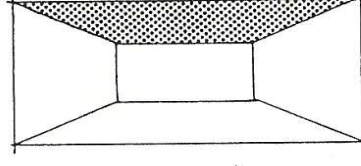

اللون الغامق في السقف يقلل ارتفاعه ، وفي الحوائط يقلل حجم الحجيره

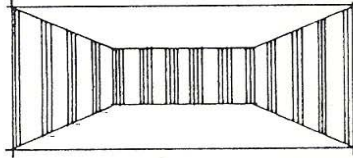

ج

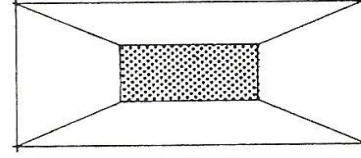

ب

السقف بلون فاتح والحوائط مع خطوط رأسيه يقلل حجم الحجيره ويزيد ارتفاعها

اللون الغامق في الحائط البعيد يقلل من عمق الحجيره .

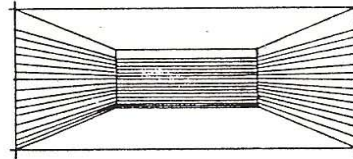

هـ

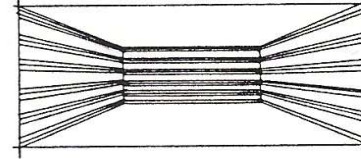

د

السقف والجزء العلوي من الحوائط بلون فاتح والباقي بخطوط افقيه يقلل الحجم والارتفاع

السقف بلون فاتح والحوائط مع خطوط افقيه يزيد حجم الحجيره ويقلل ارتفاعها

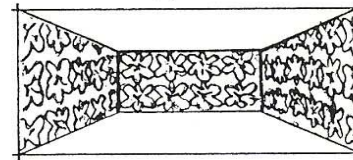

و

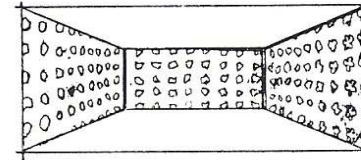

السقف بلون فاتح والحوائط بورق ذو رسومات صغيره يزيد حجمها ورسومات كبيره يقلله

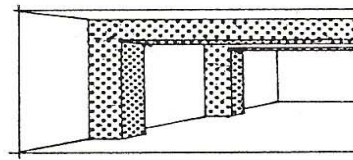

ز

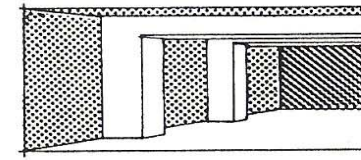

الأجزاء البارزه بلون غامق والسقف بلون فاتح يظهرها والعكس صحيح .

(- -)

-
- -
:Texture

: Types of textures - - -

:
:
:
:
:

: - - -

^٢ - دعلى رأفت - ثلاثية الأبداع ، الأبداع الفنى فى العمارة ، مركز أبحاث إنتركونسلت، ١٩٩٦م ، ص ٢٢٠

^٣ -



:

()

- - -

-

-

pattern

-

-

-

-

-

-

-

-

- -

- ()

-

-

-

-

:Color and texture



(- -)



(- -)



(- -)

^۲ dell-children-medical-center-main-lobby
^۳ - <http://www.ascinfo.co.uk/news/۲۳۴۹c-s-provides-protection-at-alder-hey>

الباب الثالث

أعمال النهو مستشفى الأطفال

الفصل الأول

العناصر المكملة للحيز الداخلى



:

- -

:

•

•

•

:

- -

■

■

■

■

■

■

■

:Natural elements

:Plants

- - -

)

- - - - -

_____ -1

-

- - - -

Importance of plants in hospital's interior space

■

■

■

■

■

■

■

¹ - جون إف بايل - ترجمة د/ أحمد الشامي - د باسم حسن - التصميم الداخلي (الأثاث والأكسسوارات) - مرجع سابق- ص ٥٦، ٥٥



(- -)

Ireland Children's Hospital



(- -)

)

- - -
- - -
- (

www.google.com/eg/imgres?imgurl=http://www.gavinjones.co.uk/images/ChildrensHospitalLondon

The psychological impact of water use in architectural space

" concomitant functions"

^٢ - Alpern,Andrew”Hand Book of Speciality Elements In Architectoure,p٢٧٠,٢٧٧



(- -)



(- -)

¹ - <http://www.sablestudios.com/WishingWell.html>

² - <http://hallfountains.com/gallery/plog-content/images/hall-fountains/architectural-fountains/miamichildrens.jpg>

:Art works

- - -

% %

:

- - - -

↳ <http://thechildrenshospital.org/about/new/art/uniqueartwork.aspx>

المستشفى:

Focal Point



(- -)



(- -)

استخدام الأعمال الفنية على حوائط المرات وفي الغرفة استخدمت الستائر المرسومة في مستشفى

CHILDREN'S HOSPITAL AT MONTEFIORE

٢- <http://www.rockwellgroup.com/projects/entry/childrens-hospital-at-montefiore>



شكل (٧-١-٣) رسومات جداريه ملونه في صالة استقبال المستشفى
لإعطاء جو من الود والترحيب للطفل^١



شكل (٨-١-٣) بالون ملون ضخيم بصالة استقبال مستشفى لويس للأطفال^٢

^١ - <http://www.mchf.org/٢٠٨٤/Ways-to-Give/Miami-Childrens-Employee-Giving.aspx>

^٢ - <http://www.conkerrcancer.org/blog/?p=١٢٠٠>

:Signs

- - -

■

■

■

■

٣-١-٢-٤-أ توظيف الفن من خلال اللوحات الإرشادية:

- () - -



(- -)



(- -)

العناصر الإرشادية المصورة والمكتوبة بمستشفى

Edinburg Children's Hospital^٣

^١ - Maklin ،Jain - Hospital interior architecture Creating Healing Environments For Special patient populations -

^٣ - <http://www.focusegd.com/edinburg.html>



Children's Hospital of Pittsburgh(- -)

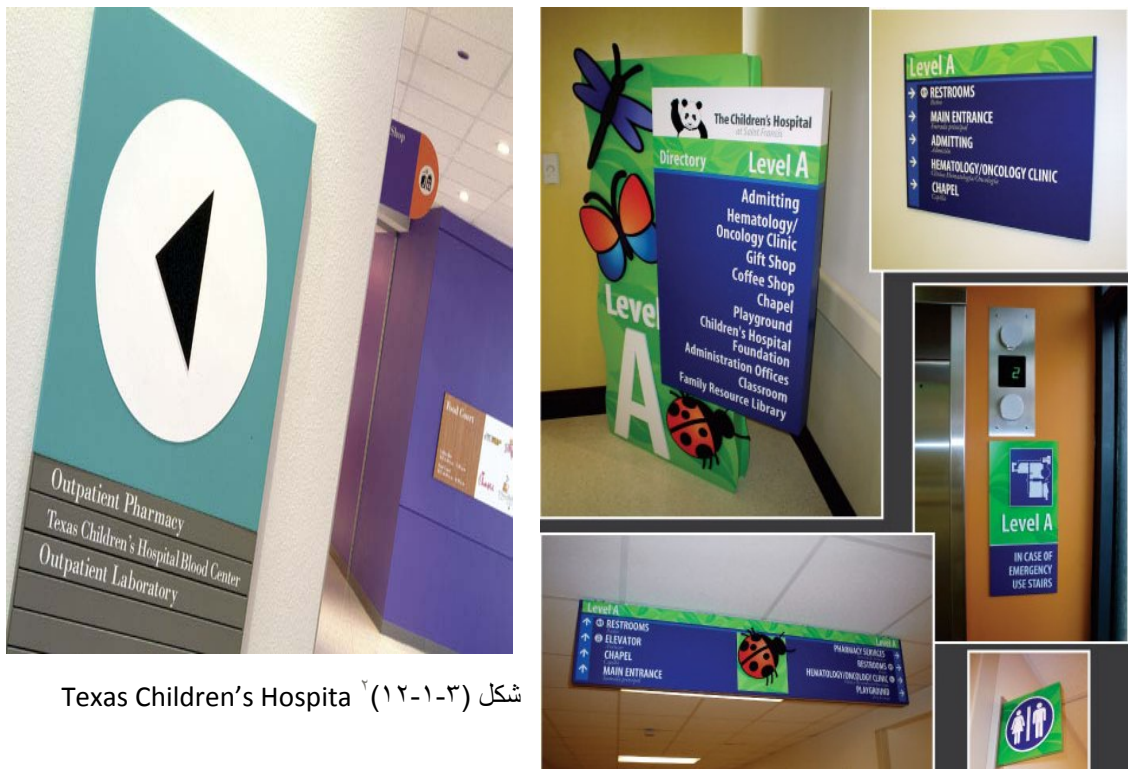

Texas Children's Hospita^١ شكل (١٢-١-٣)

(- -)

^١-<http://www.flickr.com/photos/thoughtforminc/4404627886/>

^٢-<http://www.fds.com/work/texas-childrens-hospital/>

^٣-http://www.cnfsigns.com/pages/childrens_hospital_case_study_.html

:Entertainment and enjoyment of waiting

- - -

The television:

-

- - - -

: Wall clock ساعة الحائط ٦-٢-١-٣

-

: Telephone booths

- - -

-

-

-

-



شكل (١٤-١-٣) تصميم الساعة بصالة استقبال بمستشفى
University of Chicago Children's Hospital.^٢

^٢ - <http://lynngoodpasture.com/portfolio/publicClocks.html>

الفصل الثاني

أعمال النهو للحييزات الداخلية لمستشفى
الأطفال



:

"

:

--

-

.(- - -)

-

): "



Acoustic insulation

- - -

:

- - - - -

:()

- - - - -

:

- - - - -

-:

•

•

•

:

- - - - -

)

- -

-()



-

-(

- -

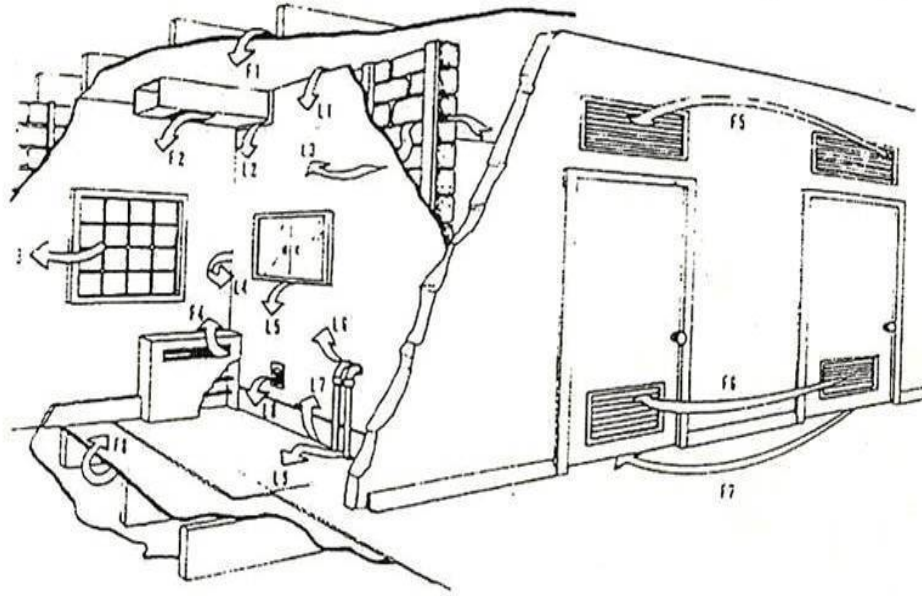

-L -F
 -L
 -L - F
 -L -F
 -F
 -L -F
 -L -F
 -L -F
 -L
 -L -F
 (- -)

-Asid, Baucom -H, Alfred, Hospitality Design for the Graying Genertion, new
 York, U.S.A., p



:

- - - -

-

-

:

-

-

-

-

-

-

-

(Fibrous Materials)

-

-

()

-

-

()

-

-1

- Alfred H. Baucom, Asid, Hospitality Design for the Graying Genertion, new York, U.S.A., ,p

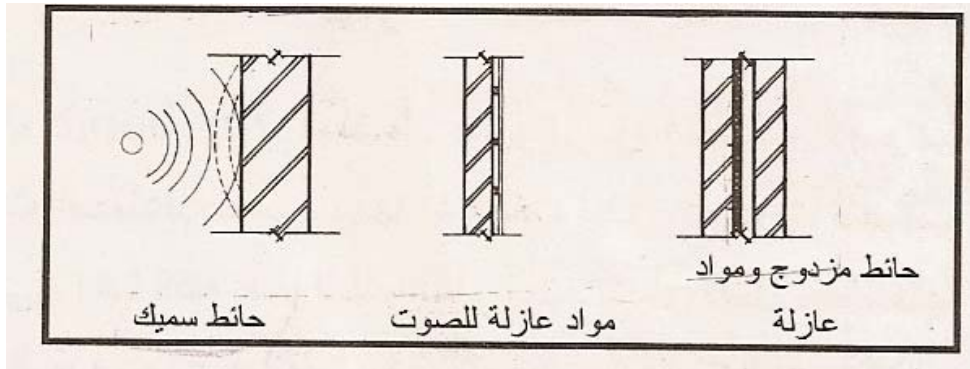

(- -)

:

:

- - - -

:

-

-

-

-

-

- ()

- - - -



-

:

- - - -

:

-

.

.

-

(

)

:



- 1



-

:

:

- - - -

:

-

()

-

-

:

- - - -

- () _____ - -

Zoning)

(diagrams

(decibels)

Sound Transmission)

(STC) = (Class

: Thermal insulation

- - -

Radiation insulation

- - -

:

- -

-:

-

-

-

: Resistance to pollution

- - -

-

-

-

-

-

-



Fire resistance:

- - -

:

-

-

:

-

-

-

-

-

Slip resistance:

- - -



-

: - -

: - - -

-

-

-

-

-

- - -

:

-

-

)

.(

:

- - - -

. X

- -

- -

- -

- -

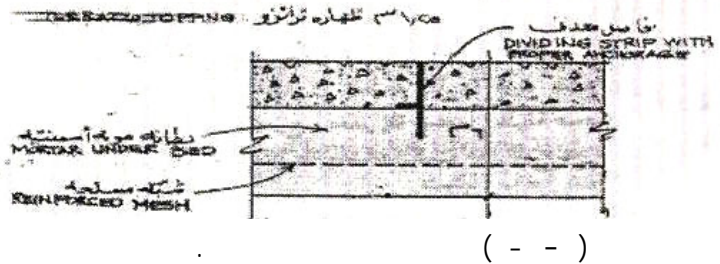
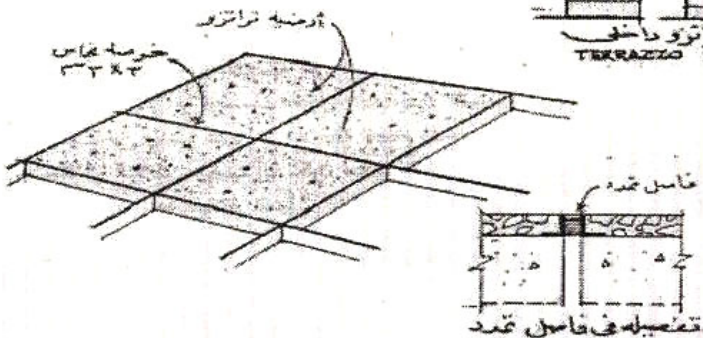

()

:

- - - -

-

-

-

-

-

-

-

ceiling:

- -

...

.

.

-

-

-

-

-

-

-

-

-

-

-

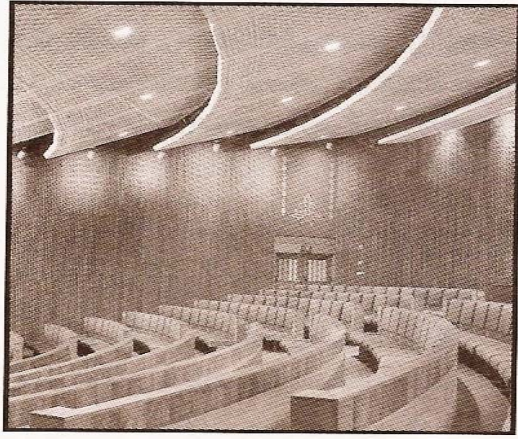

((- -))

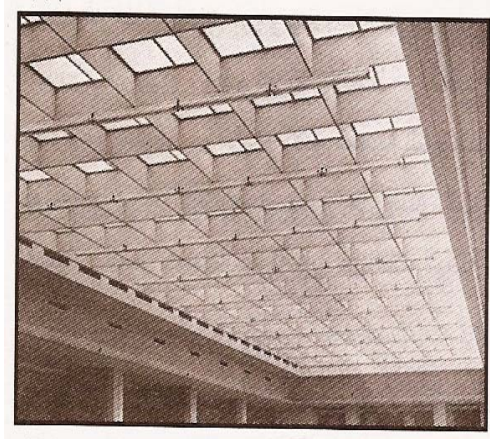

(- -)

٣- على رأفت - ثلاثية الأبداع المعماري (البيئة والفراغ) - مرجع سابق



:

:

:

:walls

- -

:

:Doors

- -

" - "

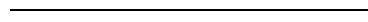

:

%

(- -)

P.V.C

- -

- -

, ۲

-



()

:

- - -

:

-

.(

)

-

-

windows:

- -

%

- Alfred H. Baucom, Asid, Hospitality Design for the Graying Genertion, new
York, U.S.A., p

- ((

))

-

-



-

- - -

•

•

•

•

•

- - -

-

x

- ()

-

- ()

-

x

- ()

- - -



-

:

-

:

)

(

:

--

(

)

:

--

P.V.C

-

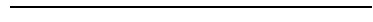

-

-)

-

-



: - -

P.V.C

P.V.C

P.V.C

: - -

()

- -

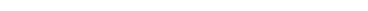

- -

-



(- -)

p.v.c	p.v.c ()		

-

-

-

-

الباب الرابع

دراسة ميدانية لمستشفيات
أطفال محلية وعالمية

الفصل الأول

دراسة ميدانية لبعض مستشفيات الأطفال
المصرية

()

- -

:Definition

- -



location:

- -

(- -)

:Components of the hospital

- -

:

.()

-

)

-

.()

)

-

.(

-

-

-

-

Capacity of the hospital: سعة المستشفى ٥-١-٤

)

(

:Hospital design

•

•

•

•

•

•



(- -)

- - - () -

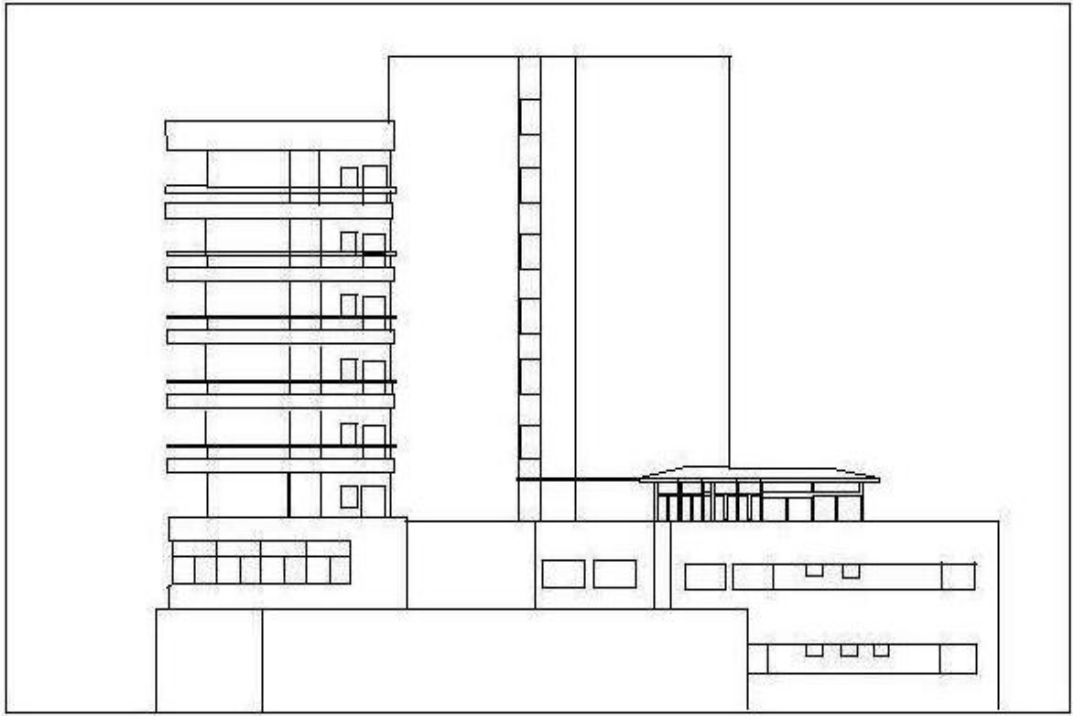

(- -)



(- -)

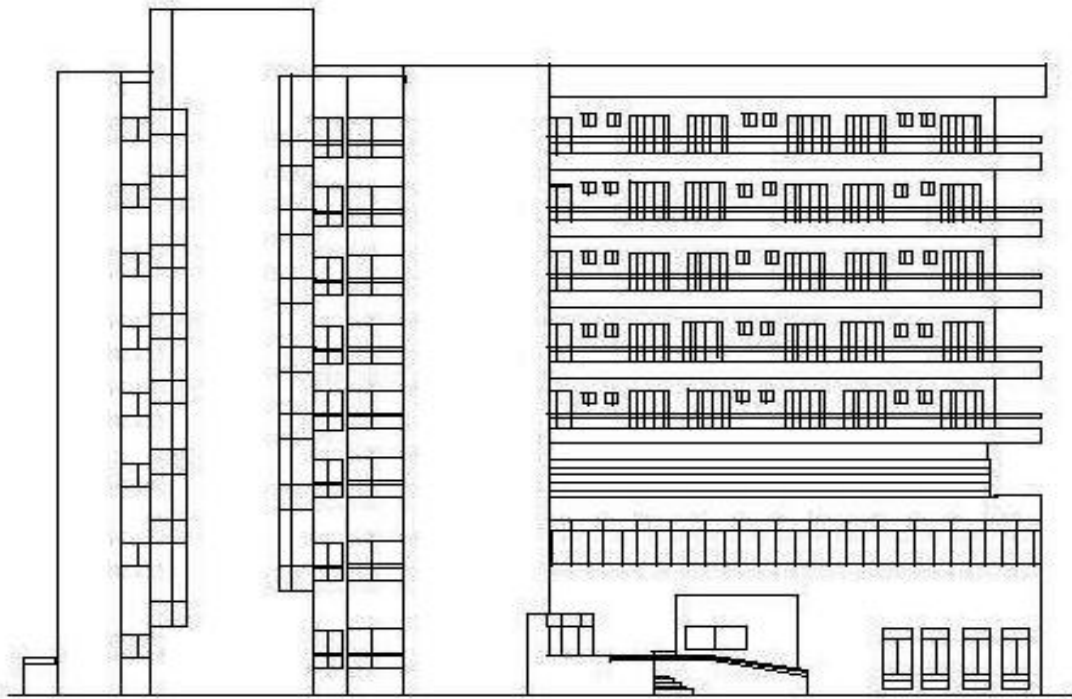

(- -)



(- -)



(- -)



(- -)

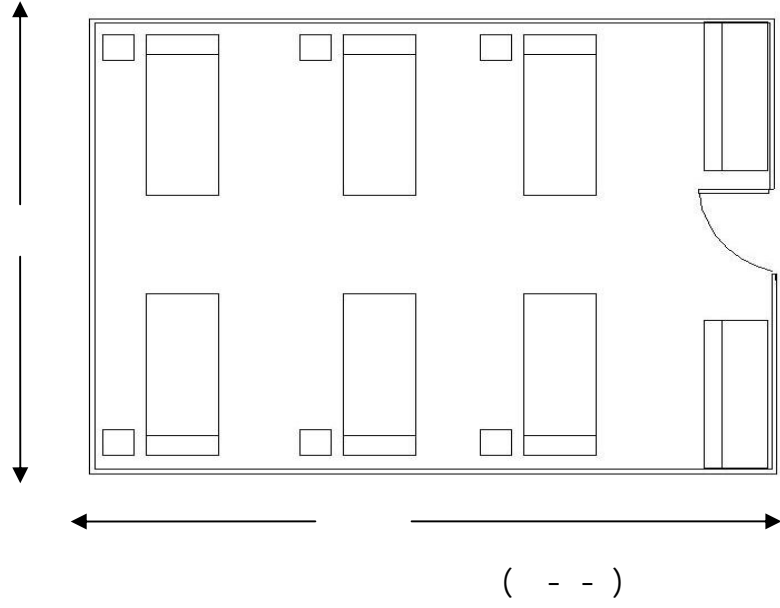
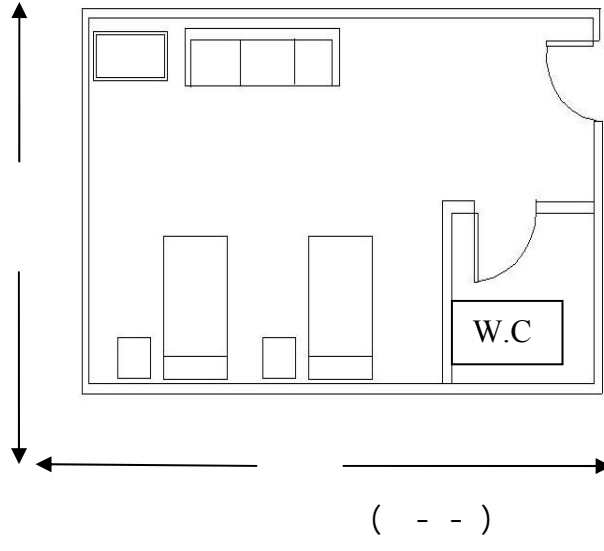
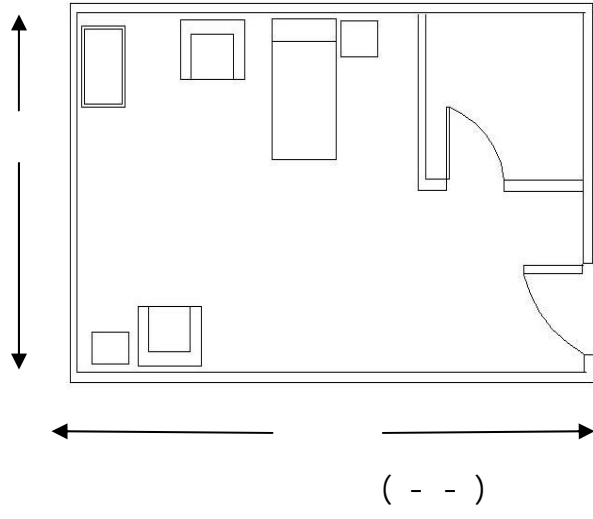



(- -)



(- -)



(- -)

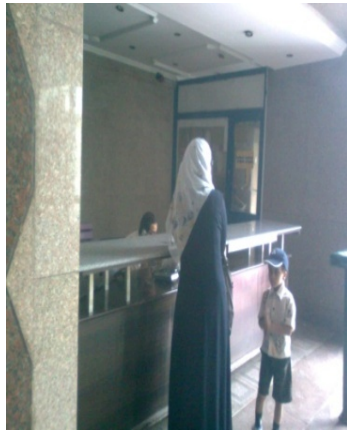

(- -)



(- -)

(- -)



(- -)

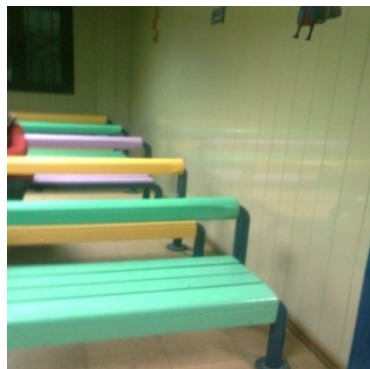

(- -)



(- -)



(- -)



(- -)



(- -)



(- -)

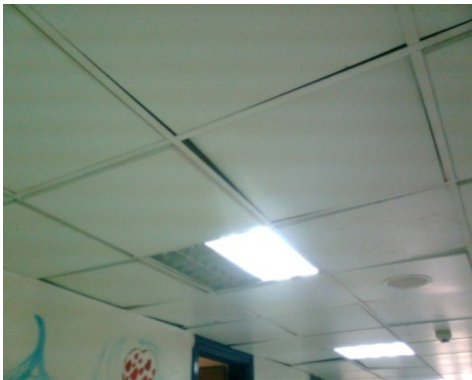

(- -)



(- -)



(- -)



(- -)



(- -)



(- -)



(- -)



(- -)



(- -)



(- -)

(- -)

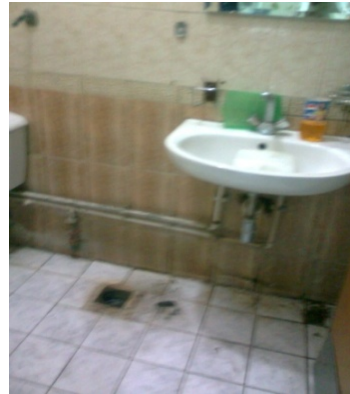

(- -) (- -)



(- -)

(- -)



(- -) (- -)



(- -) (- -)



شكل (٤-١-٤٣)



شكل (٤-١-٤٢)

شكل (٤-١-٤٤)



:Researcher opinion

:

” ”

- -
-
-
-

١ - تصوير الباحثة



■

()

■

■

■

■

■

■

■

■

■

■

■

()

-

Definition:

- -
- -



- -

: Capacity of hospital

: Design specifications

- -

■

Form Follows function



■

■

■

■

■

■

■

■

: Exterior design

- -

:Interior design

- -

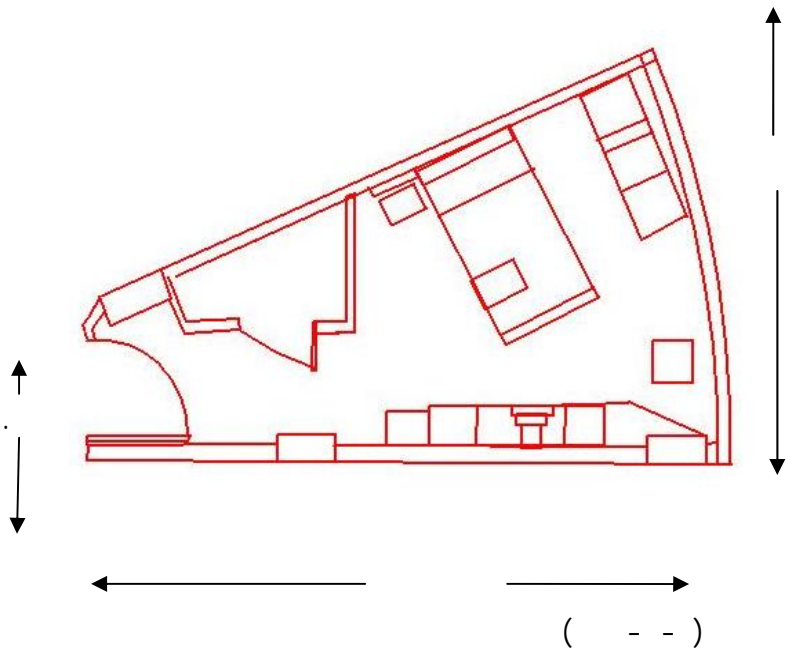

privat room

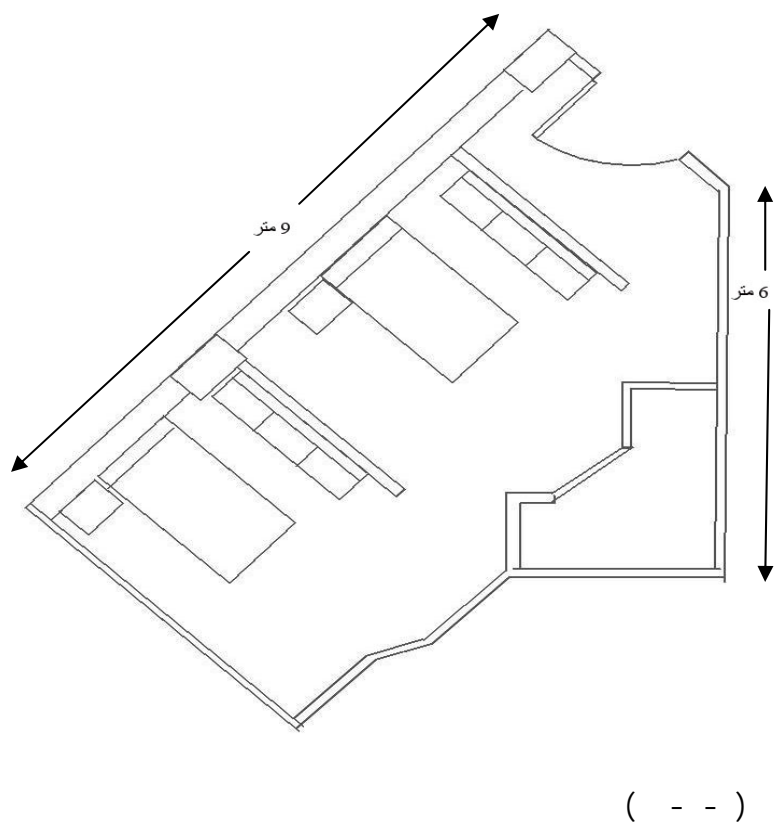

semi- private

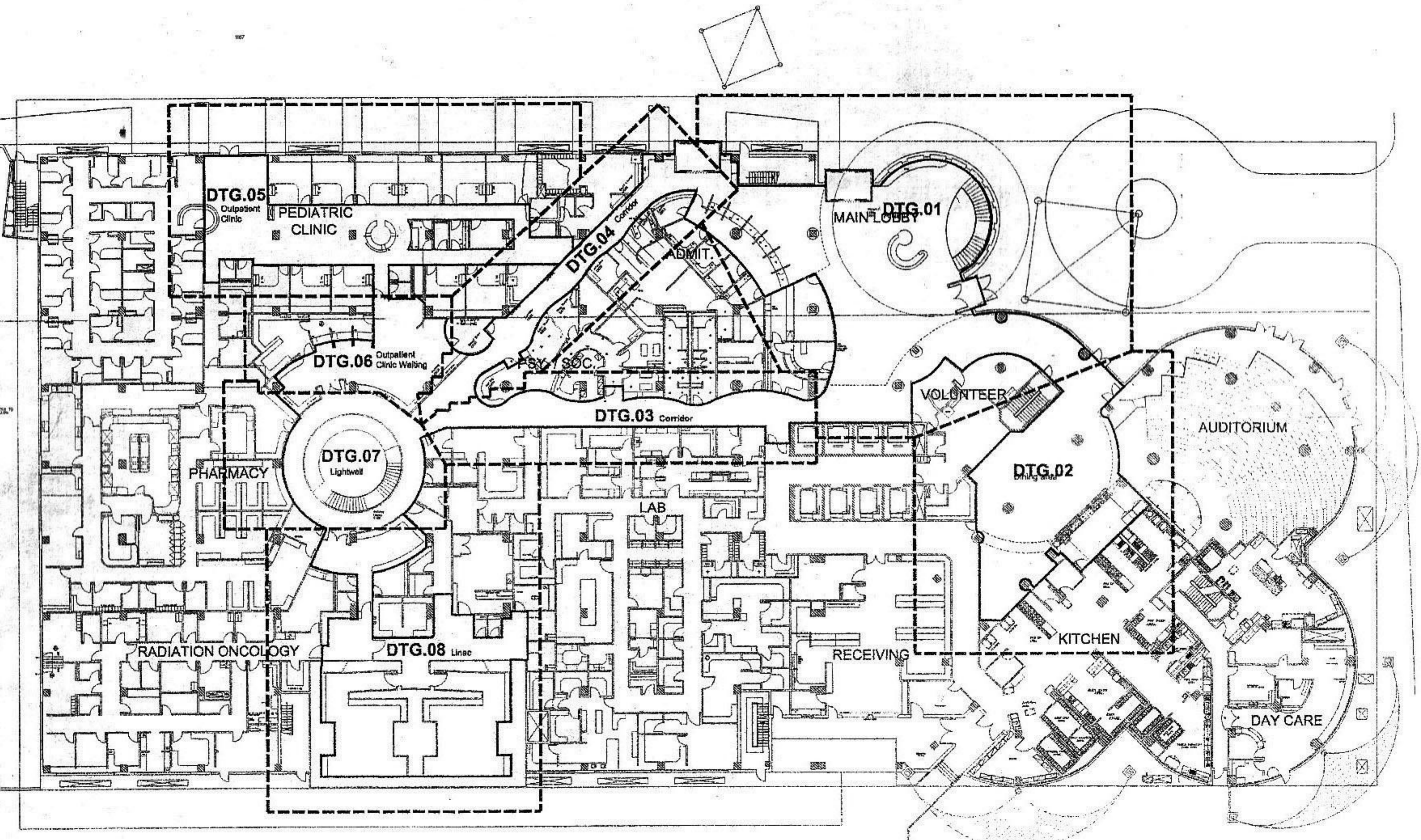

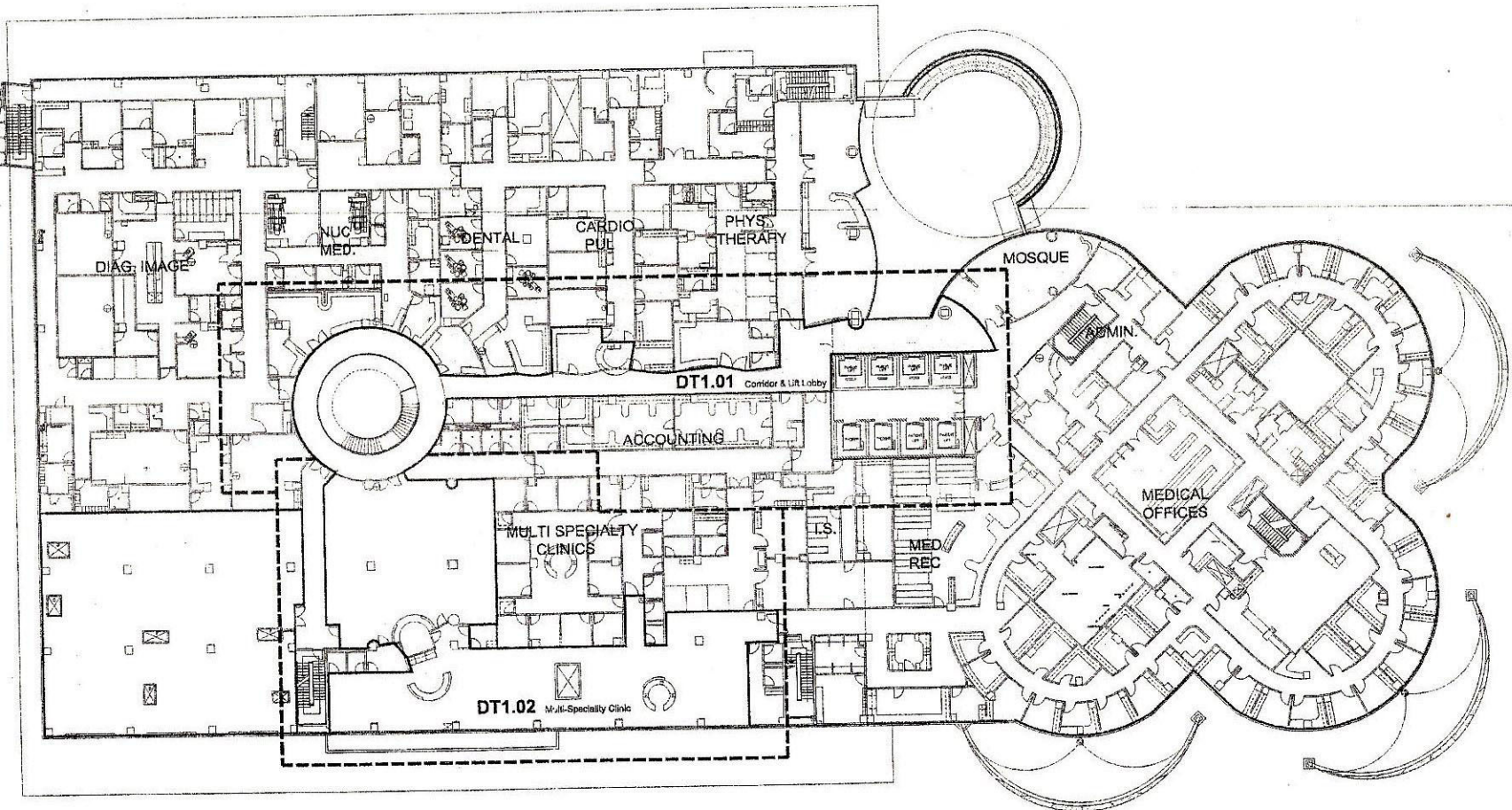

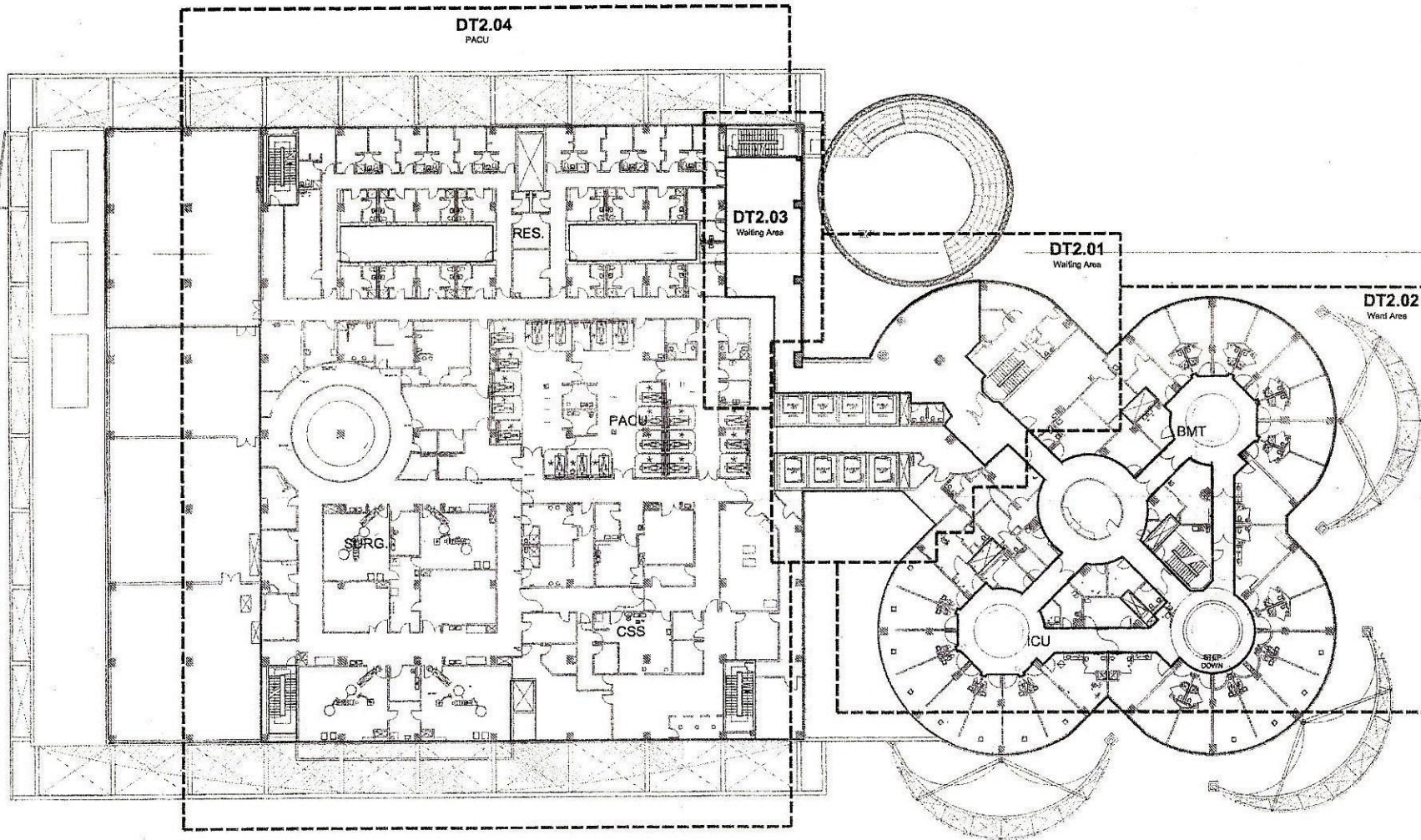

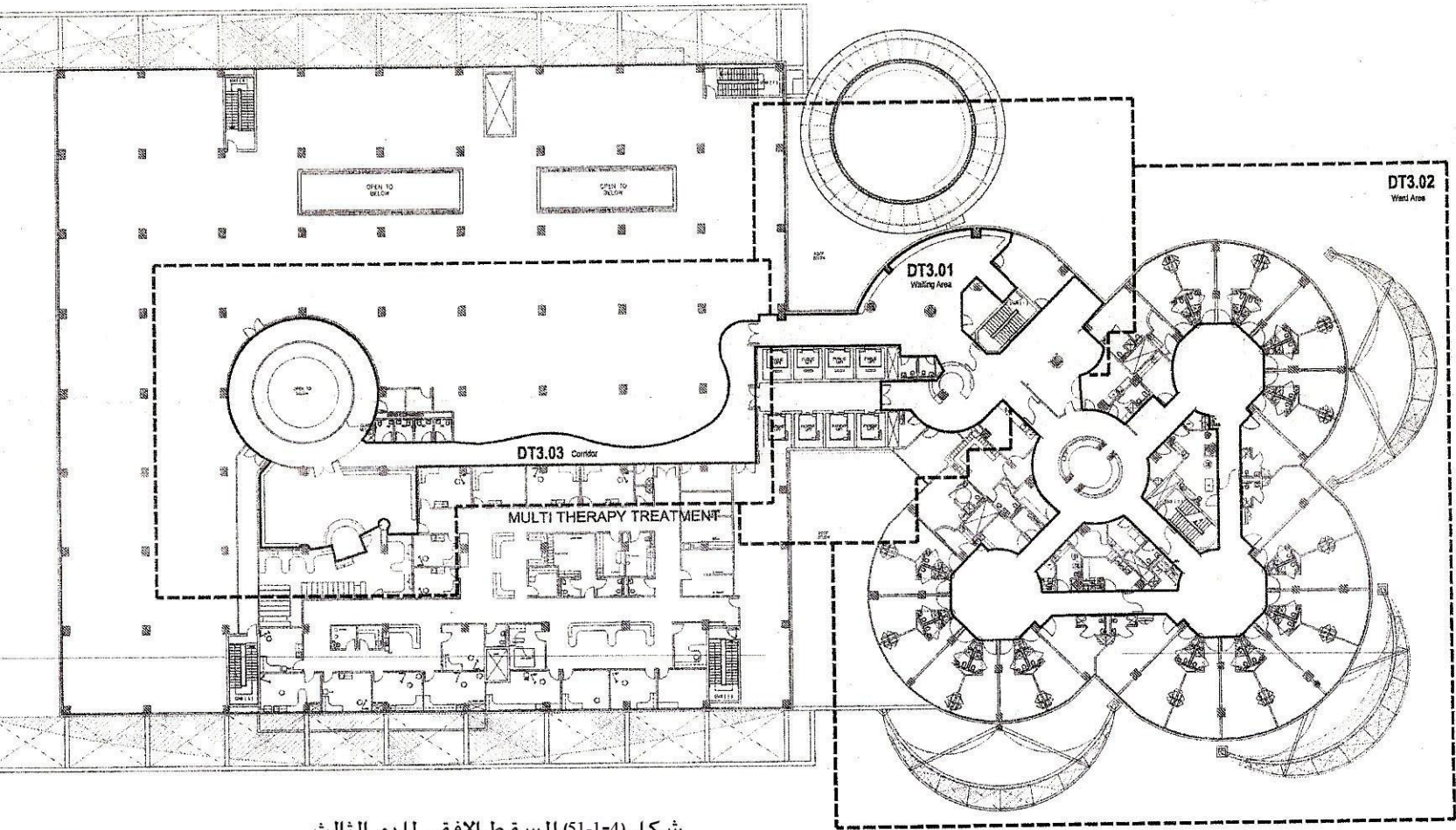

شكل (4-1-51) المسقط الافقى للدور الثالث

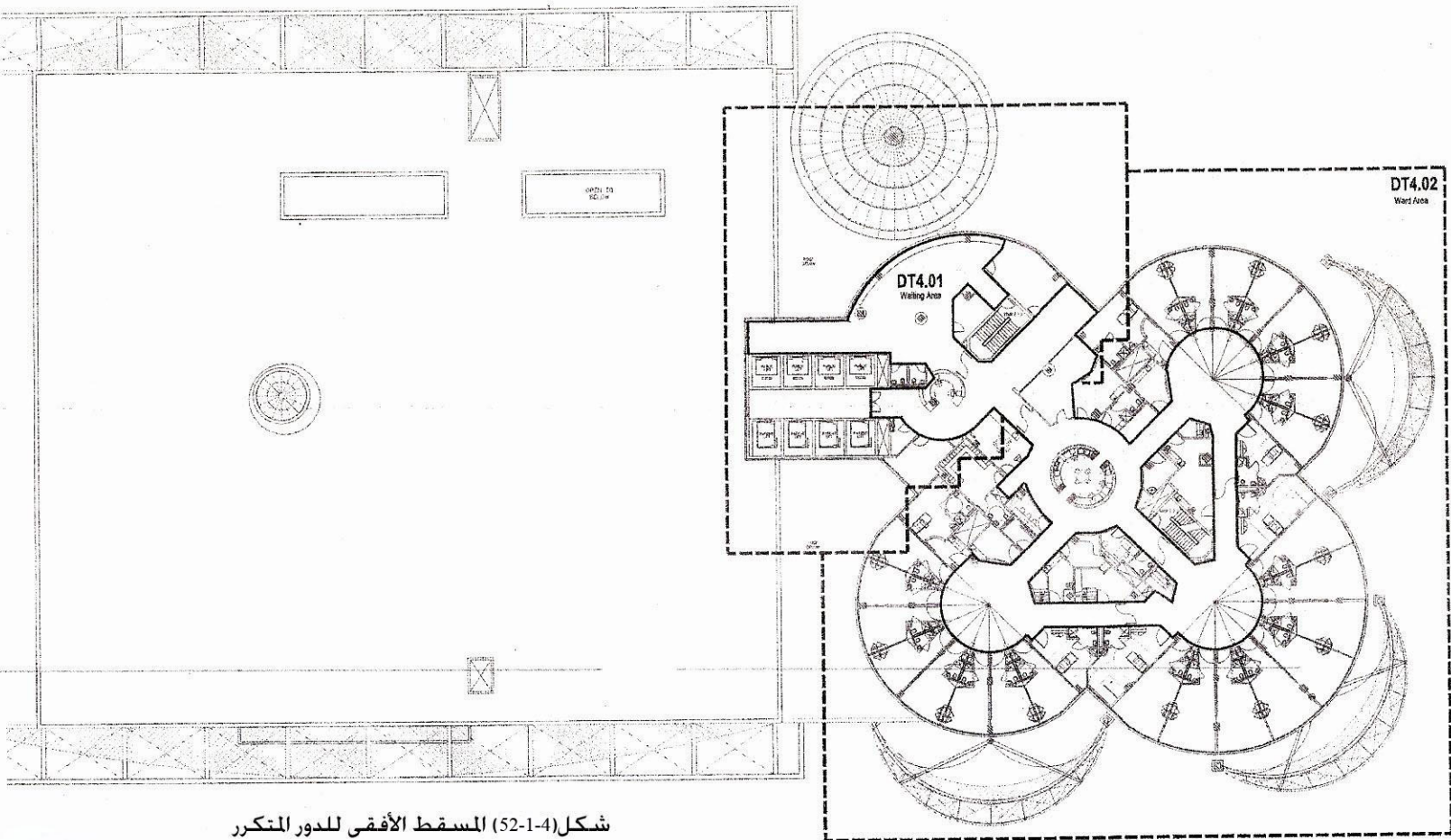

شكل (4-1-52) المسقط الأفقي للدور المتكرر



(- -) (- -)



(- -) (- -)



(- -) (- -)



(- -)



(- -)



(- -)



(- -) (- -)



(- -)



(- -)



(day care) (- -) (- -)

(- -)



(- -)

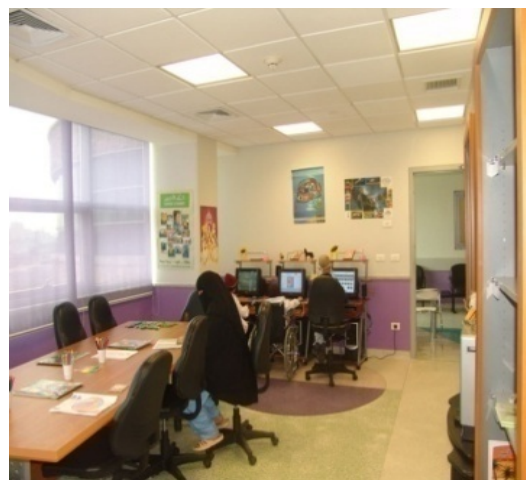

(- -)



(- -)



(- -)



(- -)



(- -)



(- -)



(- -)



:

- -

:

-
-
-

Way finding

-
-
-
-

"

"

-
-
-

:

الفصل الثاني

دراسة بحثية لبعض مستشفيات الأطفال
البريطانية

Royal Alexandra Children' Hospital

- -

:Hospital location

- -

Building Design Partnership

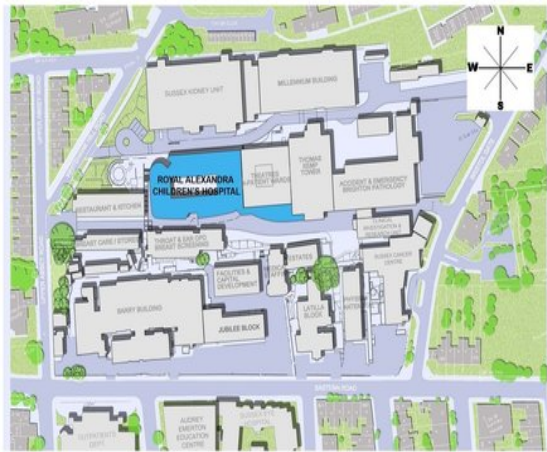

SITE PLAN



(- -)

(- -)

:Rebuilding the hospital

- -

(-)

:The main aims

- -

-

" Children's Ark' "

:Intrior design

-
-
-
- -
-
-
-
-

: Extior design

" "

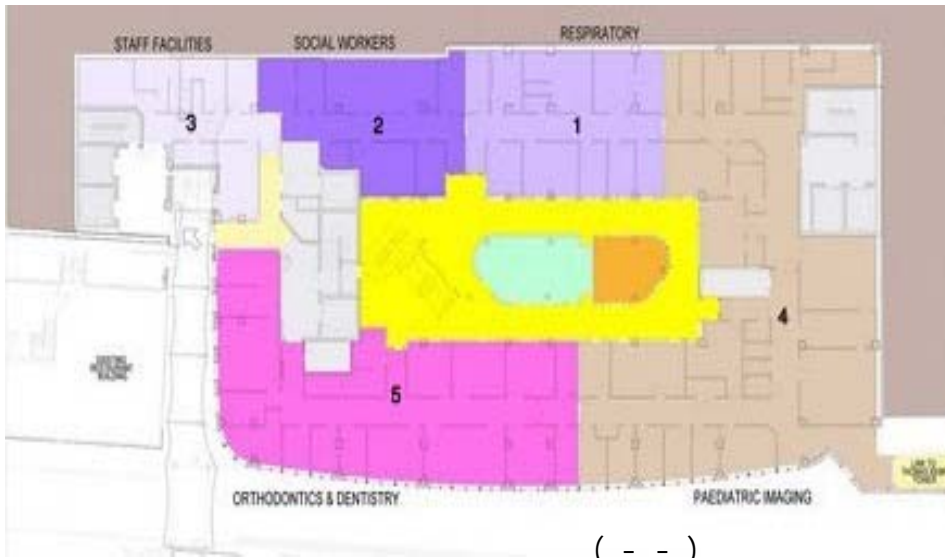

(- -)

٣- غرف الإدارة



(- -)

-

-

-

-

-

-

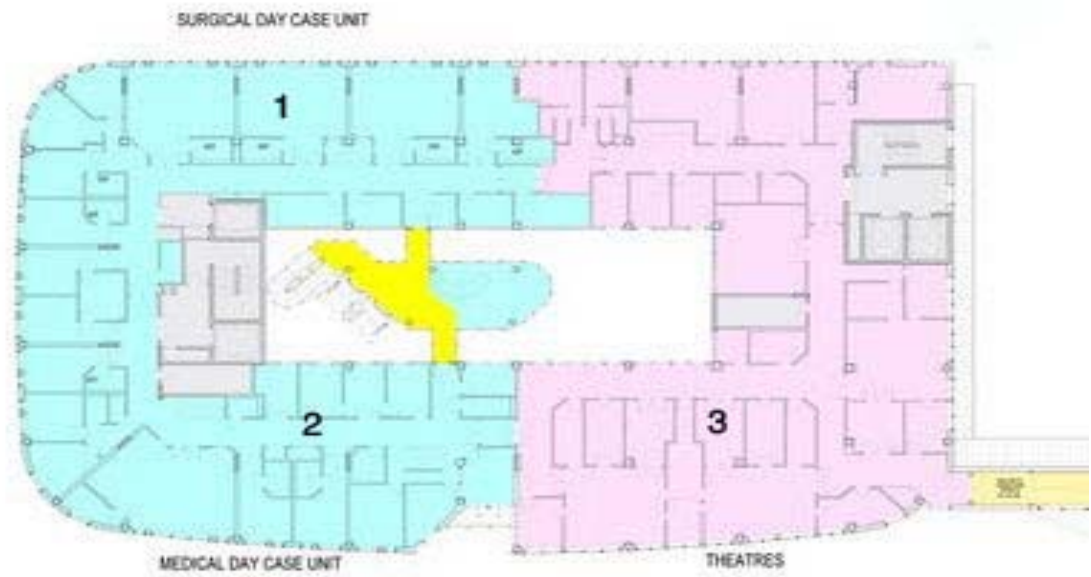

(- -)

-

-

-

-



Cross Section Looking West

(- -)



(- -)



(- -)



(- -)



(- -)



(- -)



() (- -)



(- -)



(- -)



(- -)



(- -)



(- -)



(- -)

: Royal Alexandra

- -

:

■

■

■

■

■

■

:Evelina Children's Hospital

- -

:The definition

- -

١٨٦٩

١٩٩٩

٢٠٠٢

٢٠٠٤

٢٠٠٦

Istructe

قد

أنشئت لجنة من الأطفال المرضى وأطفال إحدى المدارس المحلية ليعرضوا وجهات نظرهم في التصميم ، فلقد ضم تصميم المستشفى العديد من الأفكار والمقترحات للأطفال الصغار وعائلاتهم فهم يفضلون عادة الألوان الزاهية وجو المرح والإضاءة الجيدة^٢.



(- -)

^١ - http://en.wikipedia.org/wiki/Evelina_Children's_Hospital

^٢ - <http://www.thegarret.org.uk/evelina.htm>

:Capacity of the hospital

٢٠

١٤٠

- -

-

-

-

.)

-

-

-

External design :

- -

■

يضاف إلى ذلك أنه

- يشكل حاجزا صوتيا للضوضاء التي تأتي من الخارج .
- الواجهة الجنوبية من المبنى تجمع فائدة الاستفادة من الطاقة الشمسية

■

■

Interior design:

- -

- البساطة والكفاءة هي عناصر مهمة للتصميم الناجح – فالتصميم واضح ومنطقي ، وتقديم العديد

من الخدمات .

■ العيادات الخارجية تم تصميم مدخلها بحيث يسهل الوصول إلى منطقة الانتظار في الطابق الأرضي وبدون الحاجة إلى اجتياز الممرات الخاصة المرضى المقيمين ، فالمرور خلال هذه المنطقة الحية أفضل من المنطقة المنعزلة لأنها تشجع على خلق جو اجتماعي في المستشفى

■ تم استغلال مساحة المبنى كاملة وصولاً إلى الرصيف للاستفادة بأكبر قدر من الفراغات وأيضاً ليصبح أكثر ارتباطاً بالطريق العام .

■ القطاع L يوضح الأدوار السفلي وتخطيط العيادات الخارجية ، غرف العمليات ، قسم تصوير الأشعة و المخازن . أما أجنحة إقامة الأطفال المرضى فهي تقع بالأدوار العليا للاستفادة من المنظر الخارجي والإضاءة مع شعورهم بالأمان ، فموقع أجنحة المرضى لا يحقق فقط الاستمتاع بالمنظر الخارجي ولكن حتى يكون أكثر اتصالاً بالحركة داخل المستشفى.

■ الأطفال ذو الحالات المرضية الحرجة صمم لهم مجموعة من الغرف الفردية في الجهة الشمالية من طوابق أجنحة المرضى ، و الغرف الفردية لديها حمام خاص.

■ كل طابق في المستشفى صمم بلون ورمز معين من طبيعة العالم " البحر، المحيط ، غابات السافانا ، السماء "

■ وصمم مصعد صاروخي الشكل أحمر اللون يجذب الانتباه ورؤيته تكون واضحة سواء من داخل أو خارجها ، فالمرضى يستخدمون هذه المصاعد الزجاجية الشفافية ذات المناظر الخلابة لتسمح لهم بالتمتع أثناء الطريق إلى الأجنحة والشعور بالحركة والمرور خلال الأدوار العشرة في المستشفى .

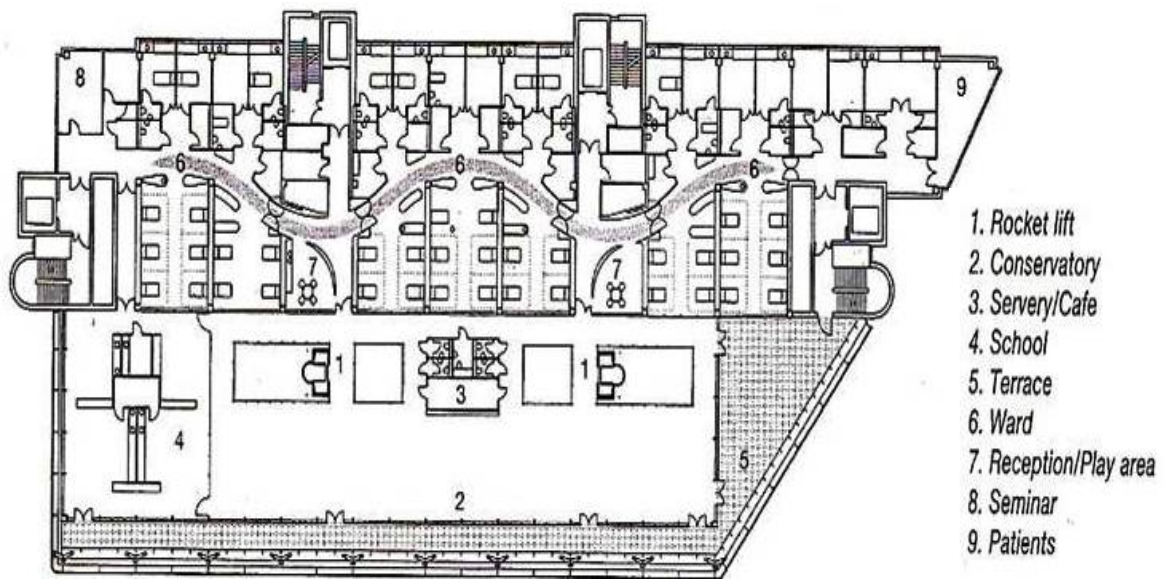

(- -)

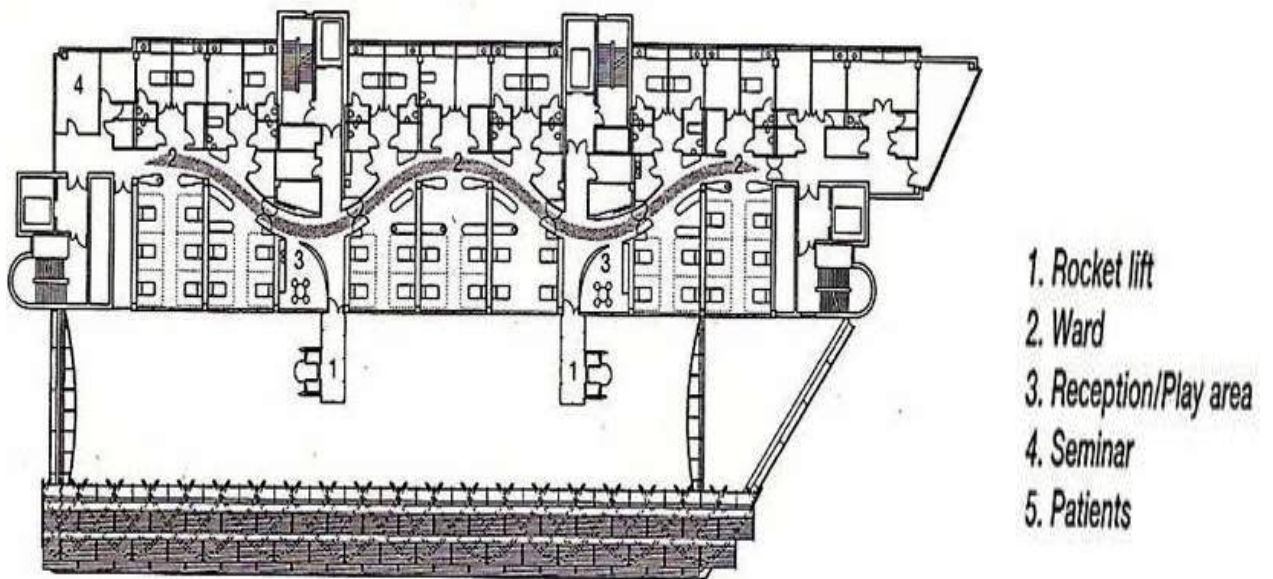

(- -)

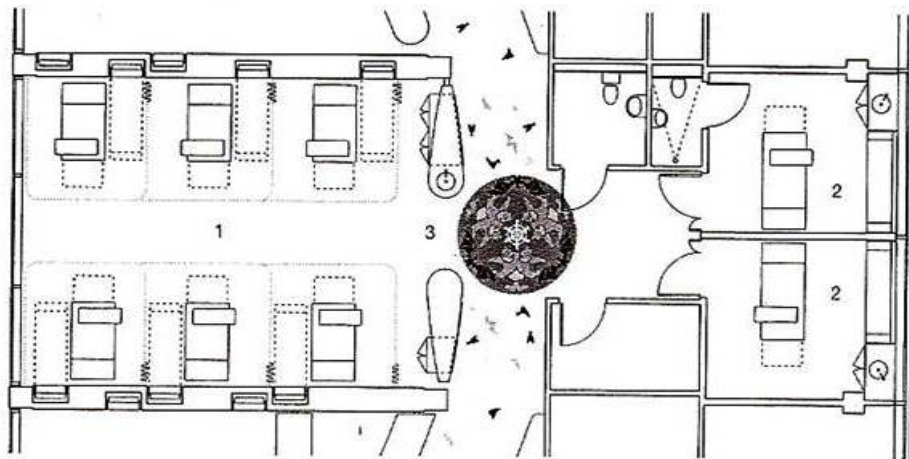

- 1. 6 bed ward
- 2. Single bed ward
- 3. Nurse station

(- -)

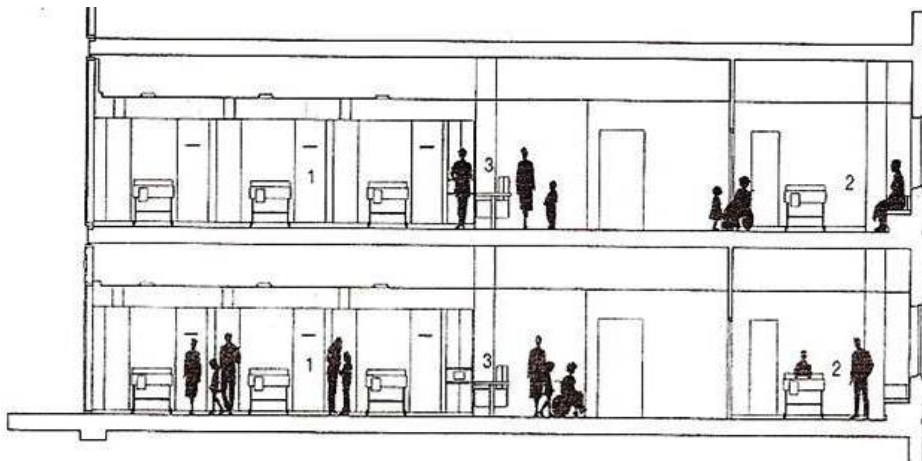

- 1. Ward
- 2. Single bed ward
- 3. Nurse station

(- -)

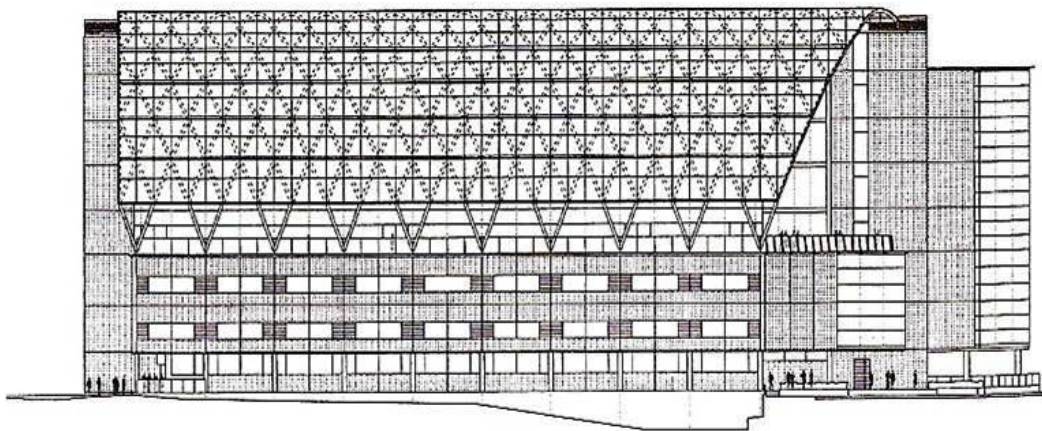

(- -)

Evelina Children's Hospital

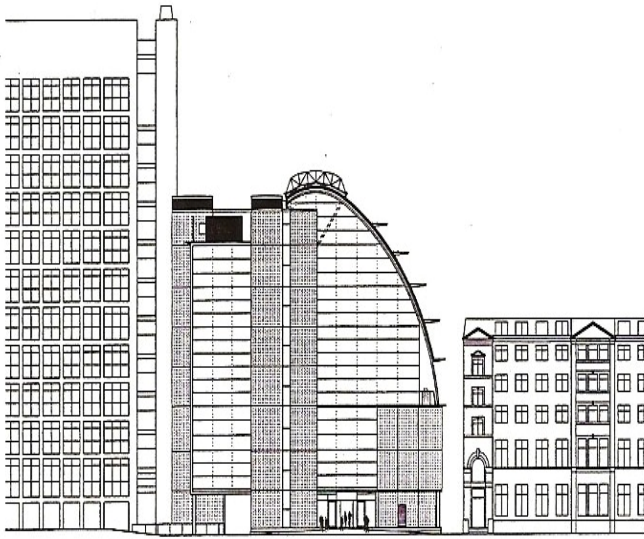

(- -)

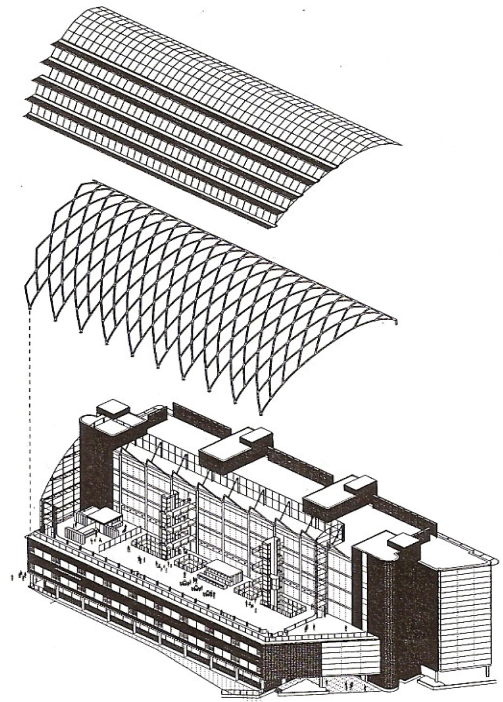

Isometric

(- -)

1. Outpatient waiting area
2. Academic Department
3. Medical Day Case Ward
4. Imaging Department
5. Paediatric Intensive Care Unit
6. Conservatory
7. Ward
8. Academic offices
9. Plant

1. Reception/security
2. Rocket lift
3. Shared waiting
4. Conservatory
5. Terrace
6. School

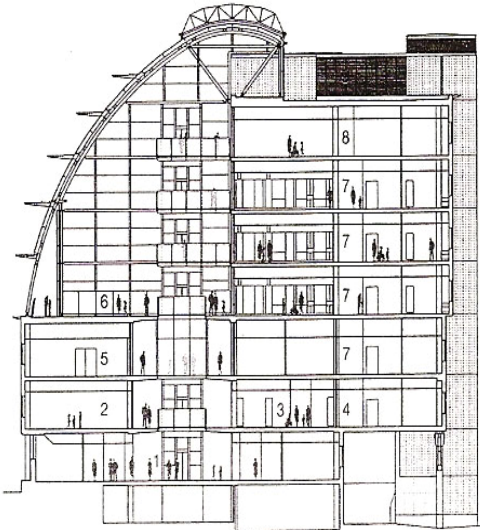

Transverse Section

(- -)

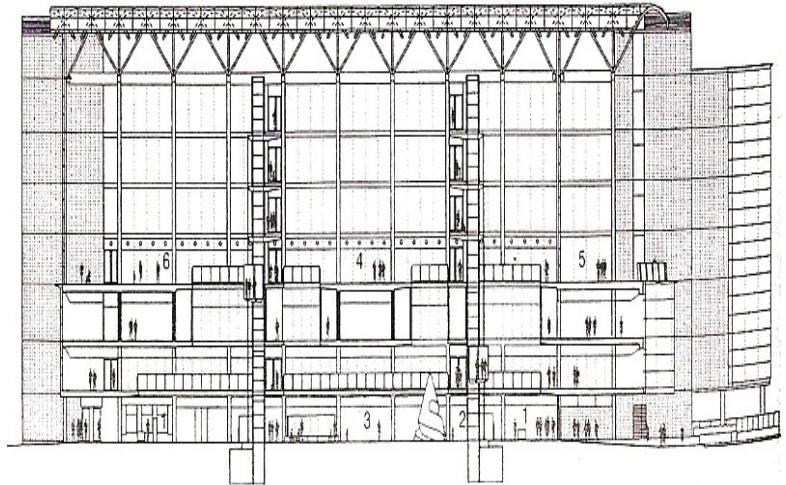

(- -)

Evelina Children's Hospital

-



(- -)



(- -)



(- -)

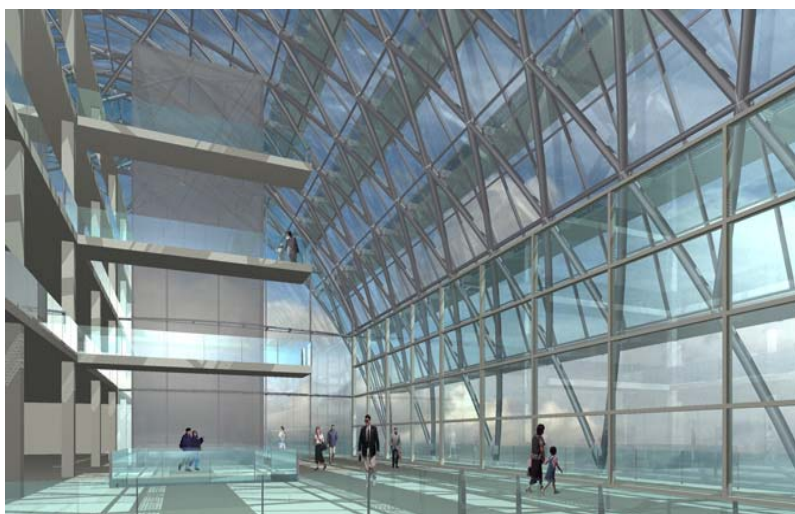

(- -)



(- -)



(- -)



(- -)



(- -)



(- -)

" "



(- -)



(- -)



(- -)



(- -)



(- -)



(- -)

(- -) -



(- -)



(- -)

: Evelina

- - -

■

■

■

■

■

■

■

الفصل الثالث

دراسة تطبيقية

Evelina Children's Hospital	Royal Alexandra Children' Hospital	مستشفى سرطان الأطفال ٥٧٣٥٧	مستشفى أطفال أبو الريش	
■	■	■	■	تعريف بالمستشفى
■	Brighton and Sussex University Hospitals ■	■	■	التصنيف
■	■	■	■	الموقع

				التخصص
				المصمم
:	Building Design :	:	:	

Hopkins Michael MJ Gleeson group:	Partnership Kajima Construction:			
				المساحة
				سعة المستشفى
				عدد الإدوار
				أعمال النهو

<p>“Fairface concrete” . Laminate</p> <p>" Terracotta cladding"</p> <p>(</p>	<p>“Wicanders ”</p> <p>modulex</p>			
---	------------------------------------	--	--	--

				الأعمال الفنية
■	■	■	■	الأثاث
■	■	■	■	النباتات
■	■	■	■	المعالجات الداخلية

				المقياس الشخصي للطفل
		تم الإستفادة من الإضاءة الطبيعية وذلك عن طريق المساحات الزجاجية الكبيرة خلال فترة النهار.	()	إستخدام الإضاءة

				العلاقة بالحيزات الخارجية
				إستخدام الألوان

النتائج والتوصيات



-:

:

-

-

-

-

-

-

-

....

-

-

)

-



(-)
-)

(-
-



-:

-

-

-

-

-

-

-

-

-

-

-

-

..... -

-

-

-



-

-

....

المراجع



	:	- 1
)	- " "	- 2
		- 3
	- -	- 4
	- - -	- 5
) -	- 6
	- - - (-	- 7
	- - - (-) -	- 8
	- - - -	- 9
	- (-)	- 10
	- (-)	- 11
	- (-)	- 12
	- - -	- 13
	- - - -	- 14

-
-
- :
- Alfred H., Baucom, Asid, **Hospitality Design for the Graying Generation**, New York, U.S.A,
 - Andrew, Alpern."Hand Book of Speciality Elements In Architectoure", McGraw-Hill, .
 - David Adler,Patricia Tutt, Isadore Rosen Field, **Hospitals Integrated Design New metric handbook , architectural Press**,
 - Deasy. C.M , in collaboration with Thomas E.lasswell,"**Designing Places For People A Handbook on Human Behavior For Achitects,Designers, and Facility Managers**" The Whitney library Of Design, V.S.A – .
 - Florence, Nightingale, "Notes On Hospitals", Longman, Green, London, .
 - - JAMA, Regulations of Acceptance of Ultraviolet, Lamps For Disinfecting Purpose.
 - Ji-seong, Jeong – **Remarkable Hospital-** printed in Seoul, Korea-published by CA Pressco.- .
 - Komiske, Bruce King - **Designing the World's Best Children's Hospitals The Future of Healing Environments-** Volume – Images Publishing , Australia .
 - Komiske , Bruce King – **Designing the world s best children's hospitals** – Images Publishing , Australia - .
 - Kurt Darr Jonathon S. Rakich, - **Hospital organization and management** nd Ed. (New York: SP Medical and Scientific Books, .
 - Maklin, Jain - **Hospital interior architecture Creating Healing Environments For Special patient populations** – Van No strand Reinhold Company – USA – .

-
- NSH Estates Authorized by the Department of Health Gateway number: “Improving the Patient experience” Friendly Health Care environment For Children and Young people To (the stationery office), London, .
 - Oscar, Gish-**Guidelines for health planners: the planning and management of health services in Developing Countries** - Tri-Med Books, .
 - Raymon ,D. Garrat - **Hospitals-a systems Approach-** st Ed. Philadelphia :AVERACH publishers Inc, .
 - R. Pibouleau Bogdan M. Kleczkowski - The importance of legislation and Adminis For Medical Facilities ,with special reference to developing tration countries , **in Approaches to planning and design of health facilities-** world Health Organization- .
 - Ruga,Wayne, Designing For Senses in Healthcare Design**, edited by Sara O.Marberry,Johnwiley&Sons,Inc,USA, .
 - Senda, Mitsure – **Design of children s play environment** – United States Of America – .
 - Series, Stephen A.Kliment- **Building type basics for health care facilitates** –published in Canada– .
 - Series, Stephen Kliment- **Building Type basics for health care Facilities** – second edition – printed in USA – .
 - Zakia Hassan Shafey , B.Sc.(**children s hospital**) University College , London .
 - Tourism Ministry ; Requirements for Eco-lodge design in Egypt tourism development Authority, Cairo, .p.
- ١- <http://www.newswise.com/articles/nationwide-childrens-hospital-to-break-ground-in- -for-third-research-facility-as-final-piece-to-expansion-plan>

-
-
- ٢- http://antron.net/content/style/designgallery/ant _ _ .shtm
 - ٣- http://thecenter.typepad.com/center_for_the_arts/outreach/
 - ٤- <http://www.virtualtoydrive.org/store/product.php?productid= &cat=&page=>
 - ٥- <http://www.jetsongreen.com/ / /first-leed-plat.html>
 - ٦- <http://www.betterpublicbuilding.org.uk/finalists/ /evelina>
 - ٧- <http://local.cec-waterjet.com/jim/wordpress/childrens-hospital-of-wisconsin-terrazzo>
 - ٨- http://mca-architecture.com/portfolio/hope_children.htm
 - ٩- <http://www.splashesofhope.org/history.php>
 - ١٠- <http://uuldesign.com/home-decoration/bathroom/kid-bathroom-design-for-home-kindergarten-and-children-hospital/>
 - ١١- http://thecenter.typepad.com/center_for_the_arts/outreach/
 - ١٢- <http://www.stlcommercemagazine.com/archives/november /construction.html>
 - ١٣- <http://www.thematicdesign.com/rcProd .asp?id= &c =>
 - ١٤- <http://www.orchidsandonions.org/ / / /rady-childrens-hospital-acute-care-pavilion>
 - ١٥- <http://www.applieddesigns.ca/children/index.htm>
 - ١٦- <http://www.missouribaptist.org/?id= &sid=>
 - ١٧- <http://www.inktankdesign.com/portfolio.php?cat=environment>
 - ١٨- <http://www.thelightingpractice.com/projects/childrens-hospital-of-philadelphia>
 - ١٩- <http://www.guysandstthomas.nhs.uk/news/echimages/corridorlarge.asp>

الملخص العربي



:

قدم مستشفى جامعي متخصص للأطفال " . "

:

:

):

(

)

(

(Cikista)



()

(- -) :

.

.

:

,

.

.

:

:



:

:

/

مثل المداخل

"nursing mothers "

...



()



)

.

(

()

.

:

:

.

. ()

.

.

.

:

:

:

.

:



.

:

:

.

:

:

The Summary

Summary

Interior Architecture of Children's Hospital

Introduction:

A specialized hospital for the care and treatment of sick children is not widely recognized until the beginning of the nineteenth century, which led in 1821 to the attention of several doctors to establish Deline hospital for children, which was the first hospital in the world, speaking English, and had established in Egypt, the oldest university hospital dedicated to children "Abu Rish". But with the developments of modern Western, which took place in the world of technology or design which is reflected in turn raise the level of performance in hospitals, there is a substantial difference and large in the level of medical services provided here and there The discussion dealt with the relationship between design criteria and employment the elements of interior of architecture Children's Hospital and their positive impact on the psyche of the child patient and speed of his recovery and also raise the level of efficiency for both medical staff, nursing and administrative

This research consists of four sections are summarized as follows:

Chapter One A development and design of the emergence of hospitals consists of three chapters:

Section I of Chapter One: (a historical introduction on the evolution of thought the design in the construction of hospitals)

Reviewing the researcher the evolution of thought the design in the construction of hospitals across the eras of the historical beginning of the Paranoiac era, which dates back medicine in which about 2900 BC. M, which was allocated schools of medicine in the temples, also addressed the era of ancient Mesopotamia (Babylon), which was follow the example of the ancient Egyptians in medicine, there are Indian civilization was built hospitals and called Alsaksia (Cikista) any temples of healing, and

Summary

development The design and intellectual of the hospitals in the West, where eating Greco, Roman, Christian, medieval, ages renaissance. It reviewed the history of the emergence of hospitals in the Islamic era and the contribution of the Arabs in the development of Islam is keen to the safety of the individual and his strength and his health, which they Al pemmarstanat was considered researchers Walid bin Abdul Malik was the first built hospitals in the Islamic era . He then discussed the researcher also the evolution of thought The The design in Egypt, where he established a number of Alpemmarstanat after the Islamic conquest shortly have the governors, the Amawyeen established Pemmarstanat in the house of Abu Zabid in an alley jellyfish Fust at were successively after the establishment Alpemmarstanat in ancient Umayyad with the aim of providing health care at the highest level and is Mansoori Hospital (Bimarstan Qalawun) of the most important and famous Cairene Alpemmarstanat that have proved efficient and functional. Also revered to the beginning of the emergence of children's hospitals globally and locally.

Section II of Chapter I: Children's hospitals (concept - classification - principles of design)

Researcher dealt with the definition of concepts such as hospitals, the general concept of the Hospital and Children's Hospital concept and definition, as well as the types of hospitals and classified in terms of medical specialization of the hospital, the owners, and its size, quality, location. Demonstration of the basic design of the hospital, how to direct, and pointed out that the best guide for halls of service and treatment is the north-east to north-west, and the conditions that must be met in the hospital grounds the relative calm and away from the noise, to clarify how to access them. Also addressed the components and the basic elements of the hospital where they can be divided functionally into six main sections are: nursing units, partitions detection and treatment, outpatient, medical assistance, public services, management may refer to the basic

Summary

considerations that must be observed at the start of the design process, such as user participation, and the availability of an element of flexibility because of the constantly changing methods of treatment and medical care, ability to stretch and expand and the importance of human dimension in the design of the hospital is for the patient refuge and shelter, which hopes the healing and wellness, and there are design considerations for children design of the hospital should be suitable for all stages of the children age and meets their needs such as providing an environment characteristic of the aesthetic, safety elements. And may refer to the role of design in reducing the chances of transmission to the hospital and the importance of mechanical ventilation, which play a role in the blanks and the application of positive pressure or negative depending on the patient's condition is also referred to the importance of the study and anthropometric and Alerjonumiks and its uses in an appropriate design for the world of children.

And Section III of Chapter I: Psychological needs of the child in the hospital:

Address the needs of psychology of the child within the hospital and its impact on process design, a child has many behaviors and desires that must be taken into account because they are the factors that speed up the process of his recovery, for example, the importance of presence of the family as a parent Oklahoma by providing a kind of family atmosphere setting the right place for them in terms of the Privacy and comfort, the emphasis on the idea of social networking for the child and the provision of climate which is paid to communicate with others so as not to rely on isolation and seclusion itself, which leads to other problems as the child needs to strengthen his sense of privacy in the hospital because it proved that most of the causes of concern is having to sleep in a room shared with strangers is one of the important reasons that made the newly-built hospital systems designed system stay in individual rooms. Also compatibility and harmony with the

Summary

environment around it and stimulate the imagination and creativity through drawings and sculptures on the walls and the walls are very important elements to distract his mind far from the condition suffered by them because the imagination is an important part of life as it provides an opportunity to escape and the emergence of a strong and well into account the parameters own so as not to feel that in an environment that is appropriate to provide a means of comfort to him when there is comfort to the sick child is assisted on the relaxation, when all the components in balance with each other and be harmonious environment so as not to tend to one element on other elements, as there is an urgent need the importance of child exposure to sun and air to renew its relationship to the advancement of child health as fresh air renews the appetite of the child and make him feel lively. The researcher pointed to the child's need for movement, play, and their benefits and their significance for him, and design considerations that must be considered places of play and provide recreational theater elements, celebrate Hall, Room View, puppet shows,,, etc.

The second chapter is the internal architecture of the components of the Children's Hospital consists of two chapters:

Section I of Chapter two: Standards into the design of the procedure:

This chapter reviews the standards into the design of the internal hospital has made it clear that these criteria and the bases starting from the design The design of the outside of the hospital from the outside must be simple and easy to understand and attract attention because the exterior of the building is an important start to experience the healing of the child. Into account the provision of green spaces, the basic idea is that nature and art are important for the health of recent studies have shown a relationship between the presence of the patient in a natural environment and its ability to overcome the pain and healing. It was pointed out architectural elements making up the hospital, the child such as the entrances of Foreign Affairs

Summary

and standards design, yard reception and components and special considerations such as the provision of parking, toilets, places for mothers incubator "nursing mothers" and babies to feed them and change their cloth, wings of emergency is that the space architect assigned to receive emergency situations or incidents or ... To provide medical care for her, Rooms residence of the child and considerations design it such as furniture, toilets their own, appropriate to their standards, Outpatient Department, who is on the process of integrated diagnosis and treatment has sung the patient stay in the hospital wards intensive care, which is a section dedicated to serve patients in critical situations on the over 24 hours and as much care of very high and much of the specialty as appropriate, the wings of operations are the surgeries on the patient after the examination and different size of the partition of any number of operating rooms by the by the size of the hospital and is considered one of the most important sections in the hospital, where the importance of the service provided. Also discussed how to apply scientific methods to find their way around easily inside the hospital without the need to question, has reviewed the design of the foundations of whether the horizontal motion paths, elevators, stairs and corridors and the distribution of these elements and their relationship to another.

Section II of Chapter Two: Elements show the internal architecture of the Children's Hospital

Show contains elements such as light, color and texture and characteristics of them. And reverred to the role of designer and his deal with light as a form of energy must be controlled where it is lighting the most liquid and the design process and the excitement and mystery and the relationship of light and shadow, and its impact on the child in terms of psychological, physiological, source of light (natural and industrial), the importance of natural lighting to the hospital the child and the means of control. Also addressed the use of colored lighting treatment, the conditions for

Summary

successful lighting, lighting the roads, emergency lighting, lighting design of the foundations of the right of the child to the hospital as well as the most important criteria for the design of lighting and affecting the interior design. He referred to the color and the effects of psychological and physiological him on the health of the sick child and hired identify trends in the movement correctly in the spaces internal to the hospital and there is also a function of color such as determining the areas and shapes and to distinguish the blocks, the impact on human feelings, the strong influence of deceiving the human visual as well as the impact of organic and therapeutic has been known therapeutic effect of color for a long time and still is the area of research in many different. Uses of color in the rooms stay, convalescence, hallways, floors and ceilings. In addition to the important role of texture in the interior spaces of the hospital and the types and characteristics and the relationship of color judging because of factors significantly affecting it...

Chapter III: Materials finishing to Children's Hospital

Section I of Chapter III: the complementary elements into the internal

Where the impact on the humanitarian needs such as furniture, interior design and its role in the integration of the performance of those spaces for the job required of them, where each element of the furniture's role in responding to the needs of users and its status so that appropriate Maya to use all types of patients, even the disabled. There are complementary elements of the furniture and equipment natural elements resources (plants, water elements), works of art for the existence of a general feeling that the interior space does not become complete until the suspension of some paintings to fill any space exists in the walls Sculpture, decorations, artwork and complementary elements (benchmarks) that promote from the aesthetic value of into the internal and can employ the art of the signs, and also the wall clock is one of the elements main furniture in waiting areas and booths telephone and use of interestingness and entertainment such as

TV in areas waiting and reception to help the users to spend time that could be long.

Section II of Chapter III of the Finishing of the internal spaces of the Children's Hospital

Having reviewed the researcher acts finishing bases used, influenced by selected some of the humanitarian needs of different as acts of isolation and security needs for the convenience of users and protect them and there are several types of insulation specialist, such as sound insulation, thermal insulation and isolation radiation voice requires the prevention of noise, whether external or internal, knowledge causes and methods of treatment and provide quiet voice within the hospital. The thermal insulation characteristics clearly evident in the ceilings where the ceiling is the most vulnerable parts of the building to the heat of the sun and then can be taken into account by using a means of thermal insulation. It was pointed to the importance of the element of safety when selecting materials, including finishing (fire resistance, slip, pollution). Chapter deals with the work of River Flooring General Specifications for floors in the hospital room, the child and the best materials to be used such as flooring alterazo, epoxy. Finishing well as the work in the ceilings, walls, doors and windows are the best materials used and the considerations that must be met in the materials used to. He also explained the work of finishing for operating rooms, radiology, laboratories, and the main corridors of the hospital stay suites.

Chapter IV, field study of selected hospitals, Egyptian and international:

Section One: A field study of the Abu Rish Hospital and Children's Cancer Hospital ٥٧٣٥٧:

Summary

Abu Rish Children's Hospital: The oldest and the first hospital for children in Egypt have been addressed in the description and analysis, as shown with pictures and explanations and engineering drawings.

Children's Cancer Hospital ٥٧٣٥٧: The field study of the Children's Cancer Hospital ٥٧٣٥٧, which is one of the most important children's hospitals in the Middle East in terms of the uniqueness of the design, has been dealt with the description, analysis, and engineering drawings and images

Section Two: a research study for the Royal Alexander Hospital for Children and Evelina Hospital in London.

Royal Alexander Children's Hospital: a research study includes a hospital, which is one of the oldest and most prestigious hospitals in the city of Breton shipping to London, which was updated in ٢٠٠٧ have been addressed in the description, explanation and engineering drawings and photos.

Evelina Hospital: It also includes a research study for the hospital known as Hospital National Health specialist and has been dealt explanation, description, engineering drawings and images.

Case Study: A comparison between the four hospitals advantages and disadvantages



Faculty of Fine Arts

Interior Architecture Department

The Interior Architecture of Children's Hospital

A thesis Presented by

Yasmine Seif El-Nasr Mustafa Hussein

For the degree of MSC in Fine Art

Décor Department - Interior Architecture

Supervision

Dr. Mohye el- Din Mohamed Wahba

Prof. of Interior Architecture of Fine Art

Dr. Hassan Abdel-Moneim Metwaly

Prof. of Interior Architecture of Fine Art

2011